

Signal Tower
Operation Manual
Model LA6-POE

Table of Contents

1. Introduction	6
1.1. Safety Precautions	6
1.2. For safe application, observe the following:	7
1.3. Product Features	7
1.4. Trademarks	8
2. Model Number Configuration	9
2.1. Model Number Configuration	9
2.2. Part Names and Dimensions	10
3. Installation	11
3.1. How to Install	11
3.1.1. Direct-mount Type	11
3.1.2. Stationary Type	12
3.1.3. Terminal block connector (Detachment Method)	13
3.2. Wiring	13
3.2.1. Terminal Block Connector Pin Arrangement	13
3.2.2. Wiring the Terminal Block	13
3.2.3. Wiring Example	14
3.2.4. LAN Cable Connection	16
3.3. Contact Capacity	16
4. How to Operate	17
4.1. Operating Procedure	17
4.1.1. Controlling with Commands	17
4.1.2. When Controlling with the Signal Line Inputs	17
4.1.3. When Mirroring	18
4.1.4. When Collecting the Signal Tower Information	18
4.1.5. Disabling a function	19
4.2. Web Setup Screen	20
4.2.1. Set password	21
4.2.2. Login	22
4.3. Network Setup	23
4.4. LED Unit Setup	24

4.4.1. Loading Setup Data	24
4.4.2. WEB Setup	26
4.4.3. Read Setup Data	27
4.5. Main Unit Setup	28
4.6. Command Configuration	29
4.7. Modbus/TCP Setup	30
4.8. Contact Input Detection	31
4.9. Mirroring Setup	32
4.9.1. Setting up the Mirroring Source	33
4.9.2. Setup Mirroring Destination Point	34
4.10. Information Transmission Setup	35
4.11. HTTP command receiving settings	36

5. Operating Procedure 37

5.1. PNS Command	37
5.1.1. Smart Mode Control Command	38
5.1.2. Mute Command	39
5.1.3. STOP/Pulse Input Command	40
5.1.4. Managing Command Control	41
5.1.5. Managing Detailed Command Control	42
5.1.6. Clear Command	43
5.1.7. Reboot Command	43
5.1.8. Status Acquisition Command	44
5.1.9. Detailed Status Acquisition Command	46
5.1.10. Individual flashing control	49
5.2. PHN Command	50
5.3. Modbus/TCP	52
5.3.1. Function Code	52
5.3.2. Input Address	52
5.3.3. Register Address	53
5.3.4. Register Allocation Example	55
5.3.5. Command Transmission Example	56
5.4. Mirroring	60
5.5. Signal Wire Control	61
5.5.1. Signal Tower Mode	61

5.5.2.	Smart Mode	62
5.5.3.	Input Signal Time Chart	68
5.5.4.	Trigger Input Signal Time Chart	68
5.6.	"Clear" Function	69
5.7.	Contact Input Detection	70
5.8.	HTTP Command	72
5.8.1.	HTTP Command Control	73
5.8.2.	HTTP Detailed Status Acquisition Command	75
5.9.	Signal Tower Information Transmission Function	78
5.9.1.	System Overview	78
5.9.2.	Communication specifications	78
5.9.3.	Transmission condition	78
5.9.4.	Transmission Data Contents	78
5.9.5.	Transmission Data Format	79
5.9.6.	Determine Signal Tower Input	81
5.9.7.	Maintain Signal Tower Status	83
5.9.8.	Visualization Application Software	83
6.	Maintenance	84
6.1.	Initialization	84
6.2.	Reboot	86
6.3.	Web Login Password Change	87
6.4.	Version Confirmation	88
6.5.	LED Color Change	91
6.6.	Buzzer Sound Control	93
6.7.	Language Data Update	94
6.8.	Firmware Update	96
6.8.1.	Firmware update of the LED unit	96
6.8.2.	Firmware update of the LAN unit	97
6.9.	Security Settings	98
7.	Troubleshooting	100
8.	Replacement Parts	103
9.	Option Parts	104

9.1. Wall-mount Bracket (Direct Mounting Type [TN])	104
9.2. Wall-mount Bracket (Stationary Type [SN])	105
9.3. Upper Bracket (Direct Mounting Type [TN])	106

10. General Specifications	108
-----------------------------------	------------

1. Introduction

Thank you very much for purchasing our PATLITE product.



- Request the installation and wiring be performed by a professional contractor if construction work is involved.
- Prior to installation, read this manual thoroughly before using this product to ensure correct use.
- After reviewing this manual, if there are any questions regarding this product, please contact the nearest PATLITE office listed on the back cover of this manual.

Notice





- The copyrights of this book is owned by the PATLITE Company, Inc. (henceforth referred to as "our company"). Any reproduction, duplication, alteration, or extracting portions of this book, etc., without written permission from our company is forbidden.
- Specifications, the design, and other contents written in this book may be changed for improvements without Prior notice and may result in differences from the actual product purchased.
- This product meets severe quality control and inspection requirements prior to shipment, but if some failure or defect is found, please contact the place of purchase, or your PATLITE Sales Representative (indicated on the last page) to solve the issue.
- Please understand that our company does not take any responsibility for damage and other disadvantages this product (software is included) has caused due to the customer using this product outside its designed application, such as for home, office and industrial use, high security applications such as systems related to human life, directly or indirectly, or from claims from any third parties.
Also understand, prior to use, no responsibility is taken at our company for damages or other disadvantages, due to customers use of this product beyond the scope of its general application, or from any claims made from third parties.
When using this product for applications in which equipment of higher reliability than the general application demands, such as a computer system, etc., please use suitable safety design countermeasures against system failure, etc.
- Please understand that our Company does not take any responsibility for damage and other disadvantages this product (software is included) has caused due to the customer using this product, or any claims from third parties.

1.1. Safety Precautions

- In order to prevent any damage to the user and other personnel or to assets, note the following:
- The following symbol classifies and explains the level of harm inflicted when caution is disregarded while using the product.

 WARNING	This symbol indicates an imminently dangerous condition: failure to follow the instructions may lead to death or serious injury.
 CAUTION	This symbol indicates a potentially dangerous condition: failure to follow the instructions may lead to slight injury or property damage.
 NOTICE	Indicates something to observe before using this product. The disregard to this indication may lead to product malfunction or failure.

■ Meaning of the symbols

Degree	Symbol	Contents
Prohibited		Indicates it is forbidden.
Caution		Indicates to show caution.
Directions		Indicates when a procedure must be performed.
Description		Indicates a supplementary explanation.

1.2. For safe application, observe the following:

⚠ WARNING

- ⚠ To prevent from shock, short-circuits or damage, observe the following:
 - Be sure the power is disconnected before replacement (fuse exchange, etc.) or repair.
 - Use this product in a properly maintained condition. (Replace or repair if the body, LED unit, etc. are damaged.)
- ⚠ Request the installation and wiring be performed by a professional contractor if construction work is involved. Failure to comply may result in fire, electric shock or falling from high places may occur.

⚠ CAUTION

- ⊘ Do not listen to a buzzer at close range. Failure to observe this may lead from irritation to permanent damage to the ears.
- ⚠ In order to maintain protection of this product against dust and waterproofing performance, be sure to use the head cover, buzzer unit, USB cover and LAN Bracket in the condition that it was originally attached. ([TN] Direct Mount Type)
- ⊘ Do not operate this product with the 'O' ring or waterproof packing removed. Waterproof performance will drop and possibility cause failure. ([TN] Direct Mount Type)
- ⊘ By all means, do not apply voltage to the Common wire (COM) or Flashing Common line. Product failure will occur.
- ⚠ When removing covers or packing from the equipment, which is attached to this product, be careful not to snag the product. Failure to comply may result in damage to the product.
- ⊘ Do not drop, or allow this product to fall. Failure to comply may result in damage to the product.

⚠ NOTICE

- ⚠ To ensure proper safety while using the signal tower, observe the following:
 - Perform periodic pre-maintenance.
 - As a precaution against problems occurring, Use this product together with other equipment.
- ⚠ Be sure to discharge any static electricity from the body before handling static sensitive parts of this product. (To prevent damage from static electricity, touch hands or other body parts to metals or an earth ground to discharge the body from static charge.)
- ⚠ Use a soft cloth, etc., dampened with water to wipe the main signal tower unit. (Do not use cleaners containing chemicals such as thinner, alcohol, gasoline or oil.)
- ⚠ To ensure safety when this product is installed onto equipment, observe the following:
 - Do not remove parts beyond those designed to be removed from this product.
 - Do not modify or disassemble this product.
 - Use only the specified replacement parts listed in comprehensive manual.

Contrary to Warnings and Cautions indicated in this document, product failure due to mishandling, disassembly, modifications or natural disasters, etc. is not covered by any Warranty.

Moreover, avoid any applications outside those indicated in this document.

1.3. Product Features

This product has a new "Smart Mode" function; in addition to the "Signal Tower Mode", which can directly control the LED and buzzer like a standard signal tower. In the "Smart Mode", various displays can be shown, such as a slow flashing rate, simulating that of a firefly and a display that can be used as a level meter.

In addition to the signal line input control, since it is compatible with the Power over Ethernet (henceforth, PoE), it can be operated through a LAN Cable to acquire signal tower status conditions via the network, and control it in the Signal Tower Mode or Smart Mode. Also, this product can use the mirroring function, in which one signal tower can show the same status as the other, but in a different location.

Since the Signal Tower is the LA6, the dedicated application software, "EDITOR for LA series" can be used to reflect the setting data via the network.

* Visit our company's home page and download the latest application software for free.

1.4. Trademarks

Microsoft Edge and Internet Explorer are registered trademarks or trademarks of Microsoft Corporation in the United States and other countries.

Google Chrome is a trademark or registered trademark of Google Inc.

2. Model Number Configuration

2.1. Model Number Configuration

	Model	LED Tiers	Rated Voltage	Mounting Specifications	Body Color	Flashing/Buzzer	Extended Functionality
Model Number	LA6-	5	D	↓	W	B	-POE

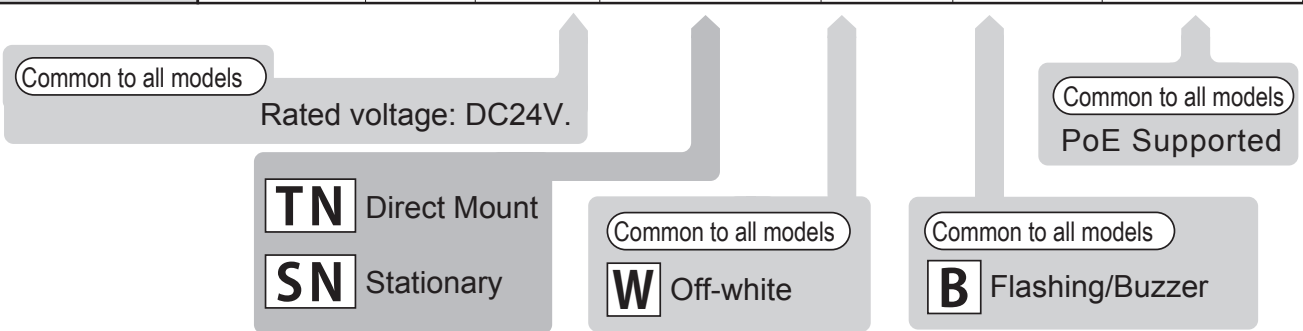

2.2. Part Names and Dimensions

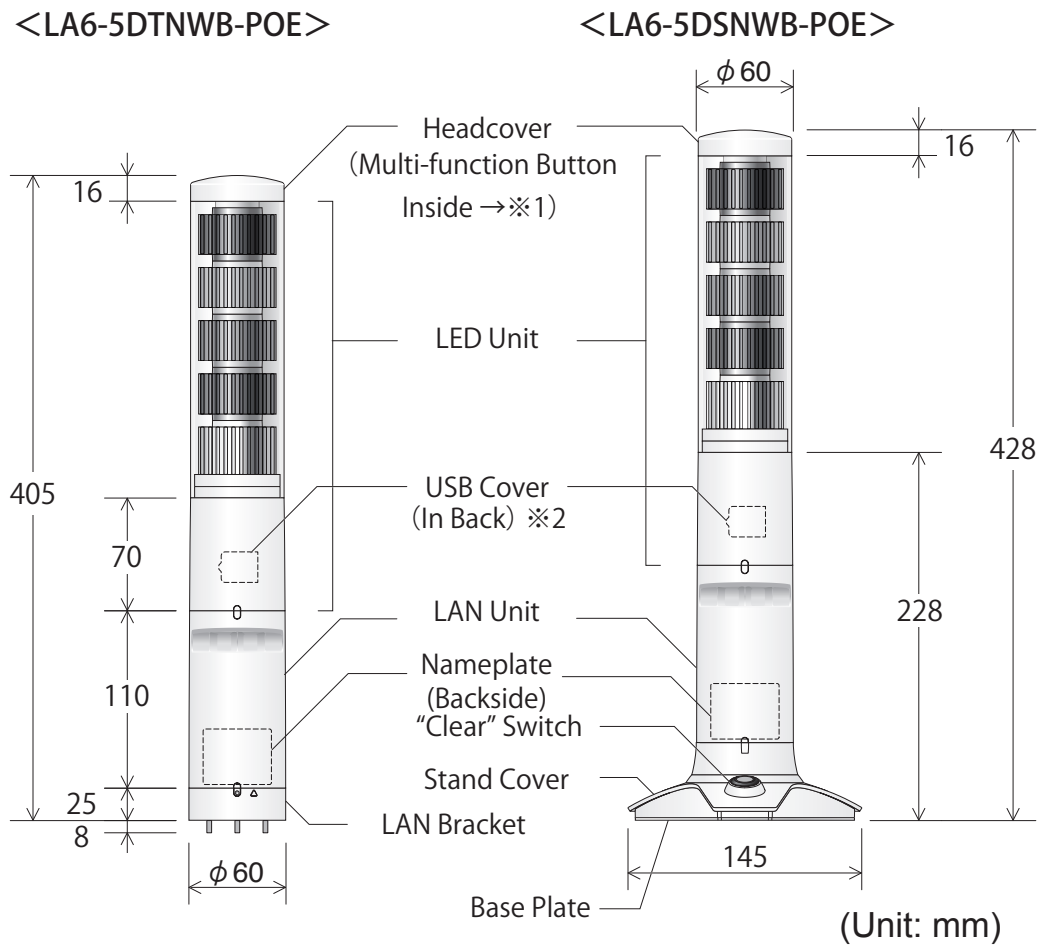

※ Maximum Board thickness: 4 mm

<p>※ 1 Multi-function Button (Remove Head Cover)</p> <p>Remove the head cover by turning it to the left to release it from the locked position. (To re-assemble, perform the steps in the reverse order.)</p>	<p>Multi-function button</p> <p>〈Note〉 This connector is not used.</p>

<p>※ 2 USB Cover (Detailed Parts)</p>	<p><NOTE></p>	<p>- To open the USB Cover, insert a minus driver (blade-edge width of 3mm, thickness of 0.5 mm or less) in the indented part and lightly pry it open. (Use an object made of ceramic to avoid scratching or damaging the Body.)</p> <p>- Ensure the USB cover is closed at all times. If not securely closed, the waterproof performance will decrease.</p>
<p>(Cover in opened position)</p> <p>18.8</p> <p>22.2</p> <p>Micro USB connector (Micro-B Female)</p>		

3. Installation

⚠ CAUTION

- ⚠ The clamping surface should be sufficient enough to tolerate the weight and surface of the product. Do not use the product in a place where vibrations exceeds the specifications. Failure to comply may result in the prevention of the product detaching and falling, causing injury to a passer-by, etc.
- ⚠ Install the signal tower in an upright position.
- ⚠ In cases where the installation placement is unavoidably irregular, and waterproof performance is required, use a sealant to the crevice between the product and the installation surface. ([TN])
- ⚠ If an IP54 rating is required, when clamping each bracket, place sealant to the distribution hole area and the screw thread or nut. ([TN])
- ⊘ Do not run LAN cable from outside. There is a risk of exposure to lightning strikes or other adverse weather conditions.
- ⊘ The LAN Unit and Stand Cover cannot be separated. ([SN])
- ⊘ Before placing the rubber sheet onto the bottom plate, be sure to removedust, water, oil, etc., on the bottom plate and the installation location. ([SN])
- ⚠ The LAN cable and wiring is not included.

3.1. How to Install

3.1.1. Direct-mount Type

- 1 Make holes for the mount and wire distribution hole for the product.
- 2 Firmly hold the LAN Unit, and the turn to the left to remove it.
- 3 Secure the LAN bracket with the accessorized nuts.

Recommended Torque
0.75N/m (Standard)

- 4 It allows the LAN cable wiring to pass through the distribution hole.
- 5 The lock on the terminal block connector can be unlocked and removed for wiring.
(Refer to "3.1.3. Terminal block connector (Detachment Method)") (Refer to "3.2. Wiring")
- 6 The LAN unit is connected to the terminal block connector and LAN cable.
- 7 The LAN unit is attached.
- 8 Sealing around the mounting holes and the distribution hole is done if necessary.

※ The figure shows the most common installation circumstances, but cannot show for every possible circumstance.

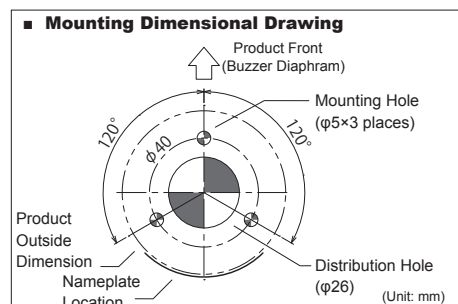
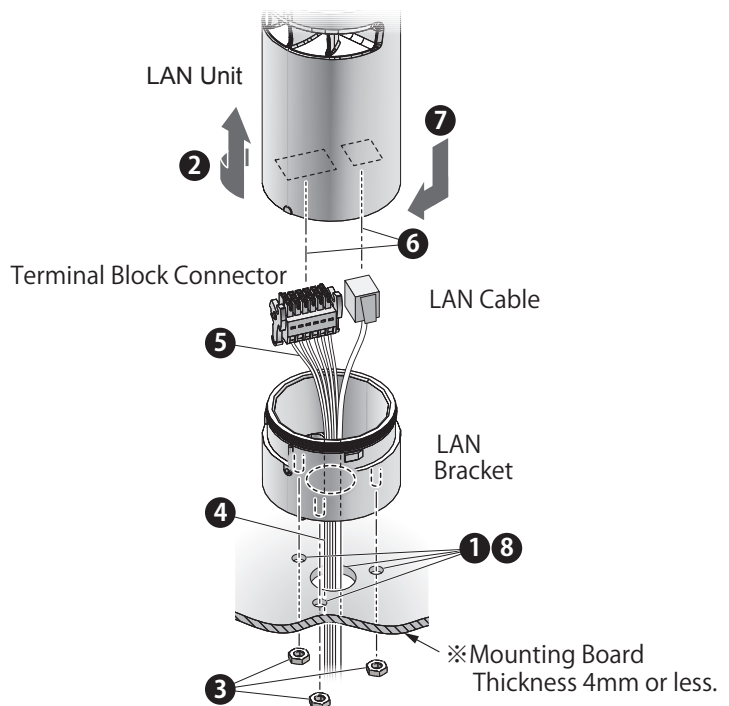

3.1.2. Stationary Type

- 1** Loosen the screw to remove the bottom plate. (Do not completely remove the screw.)
 - 2** The lock on the terminal block connector can be unlocked and removed for wiring.
- (Refer to 3.1.3. Terminal block connector (Detachment Method))(Refer to 3.2. Wiring)
- 3** The LAN unit is connected to the terminal block connector and LAN cable.

Recommended Torque
0.6N/m (Standard)

- 4** The tab on the bottom of the stand cover is hooked in place and secured with a screw.
- 5** Apply the rubber sheet onto the bottom plate. The rubber sheet is peeled from the yellow releasing paper, and is to be stuck onto the bottom plate. The transparent protection sheet on the rubber sheet is to be removed after attachment.

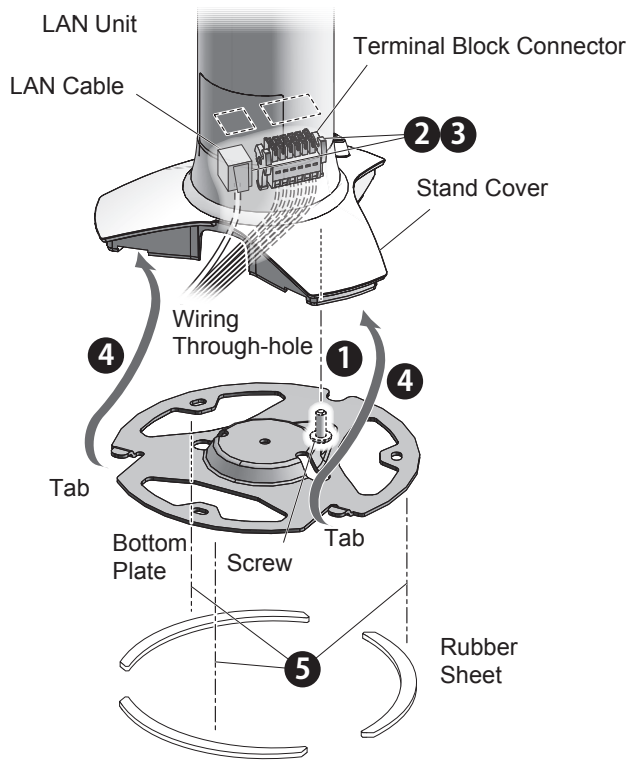

The figure shows the most common installation circumstances, but cannot show for every possible circumstance.

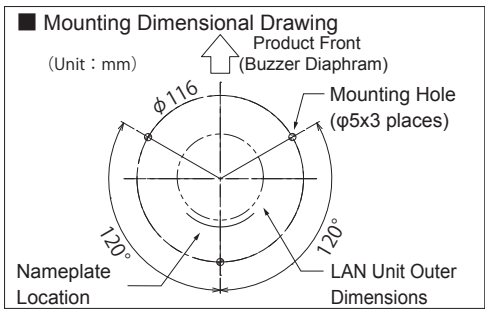

3.1.3. Terminal block connector (Detachment Method)

<Removing>

<Figure of LAN unit from the underside>

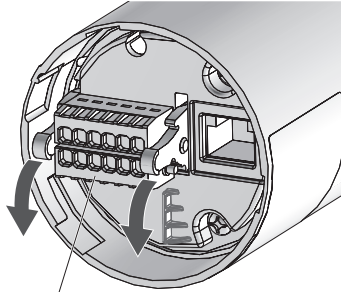

Terminal block connector

Referring to the drawing, depress the lever on the right and left of the terminal block connector to unlock it, and pull the terminal block connector straight out.

<Attaching>

※ The example figure shows the TN model.

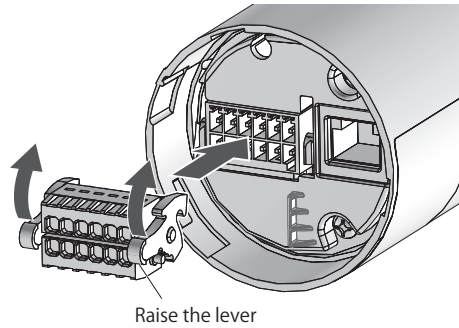

Raise the lever

Push the terminal block connector into the LAN unit until the levers can be locked in place. (When pushing the terminal block connector in place, the lever will temporarily move up, before it moves down and locks into place.)

3.2. Wiring

3.2.1. Terminal Block Connector Pin Arrangement

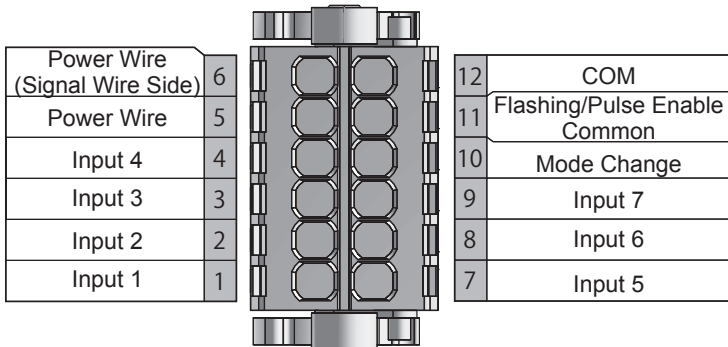

■ Recommended lead wire specifications

Wire Type	UL1007/UL1430
Wire Gauge (Solid Wire)	0.2-1.5mm ²
Wire Gauge (Frayed Wire)	AWG24-16

Temperature rating should be above 75°C, and the conductor material should be of copper wire.

3.2.2. Wiring the Terminal Block

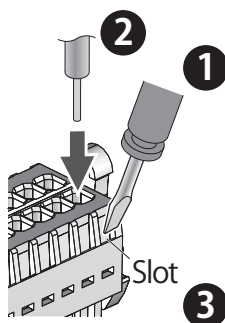

- 1 A minus driver etc. is placed on the slot and pushed into the slot of the terminal block connector. (at a slight angle)
- 2 The stripped side of the lead wire is inserted in the slot.
- 3 The driver is then extracted from the slot. (Check to make sure the lead wire has been locked in place.)

Point

The minus driver blade should be no less than 2.5mm in width and 0.4mm in thickness. Any object that fits the dimensions is also ok.
Do not forcibly push the slot more than necessary with the driver. Failure to comply may damage the unit.
Strip 6-7mm of wire insulation from the wire before inserting it in the Terminal Block.
When removing the lead wire, Do not just pull to remove.
(Be sure to slide the minus driver etc. into the slot to unlock it.)

3.2.3. Wiring Example

The following is a basic wiring example.

If there are any special applications that require asking questions concerning this product, feel free to contact your PATLITE Sales Representative.

* When lighting and flashing are used together in the Signal Tower mode with a PLC, it is necessary to separate the flashing and non-flashing circuit outputs on the PLC side.

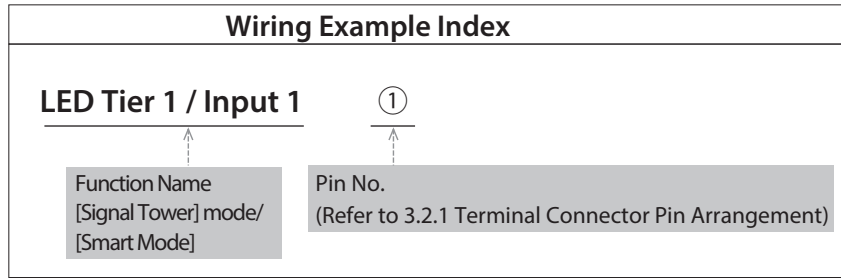

3.2.3.1. Connecting to Contact Relays with DC24V Input

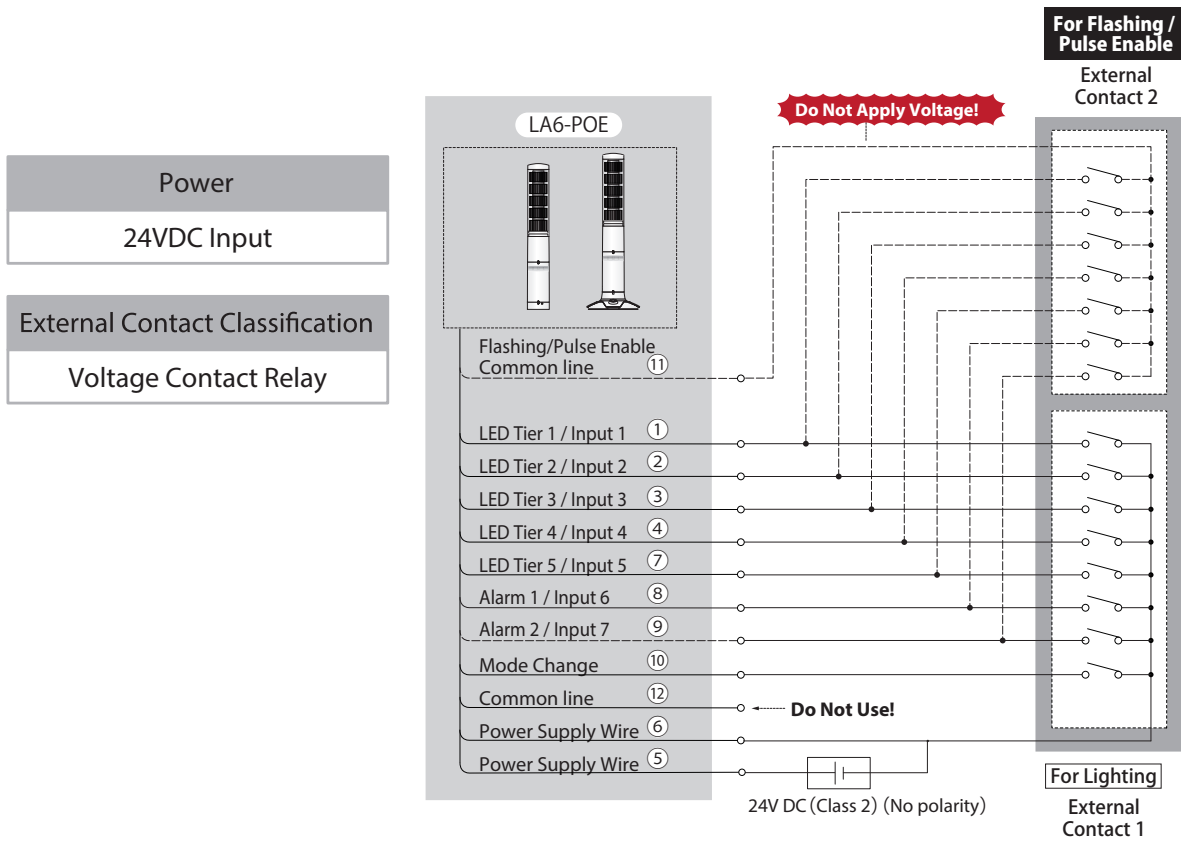

3.2.3.2. Connecting to a PLC (NPN Type Transistor) with DC24V Input

Power
24VDC Input
External Contact Classification
PLC (NPN Transistor)

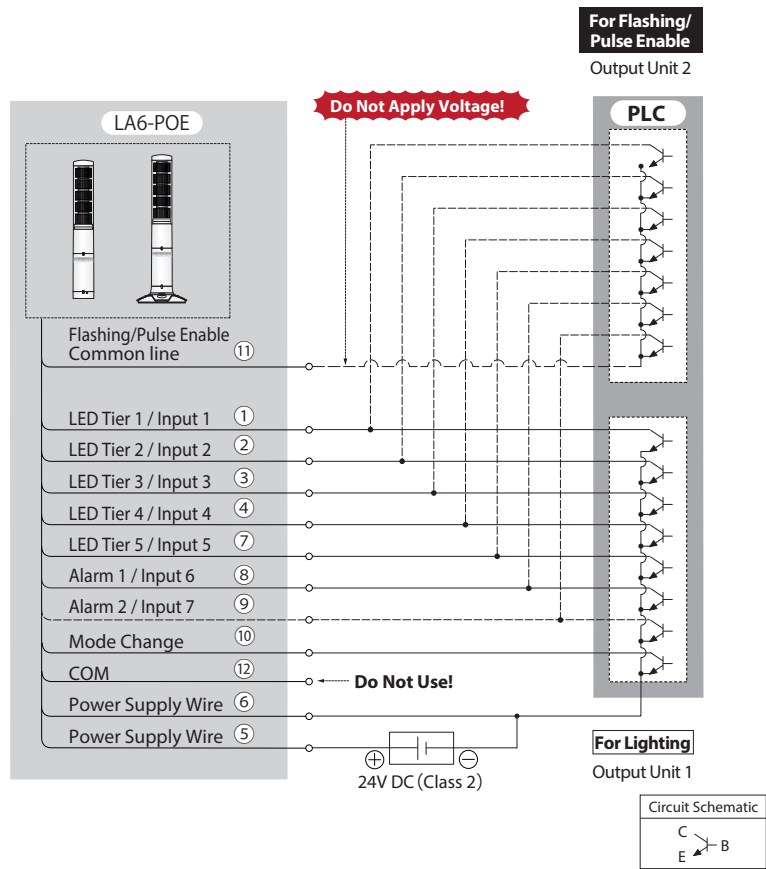

3.2.3.3. Connecting to a PLC (PNP Type Transistor) with DC24V Input

Power
24VDC Input
External Contact Classification
PLC (PNP Transistor)

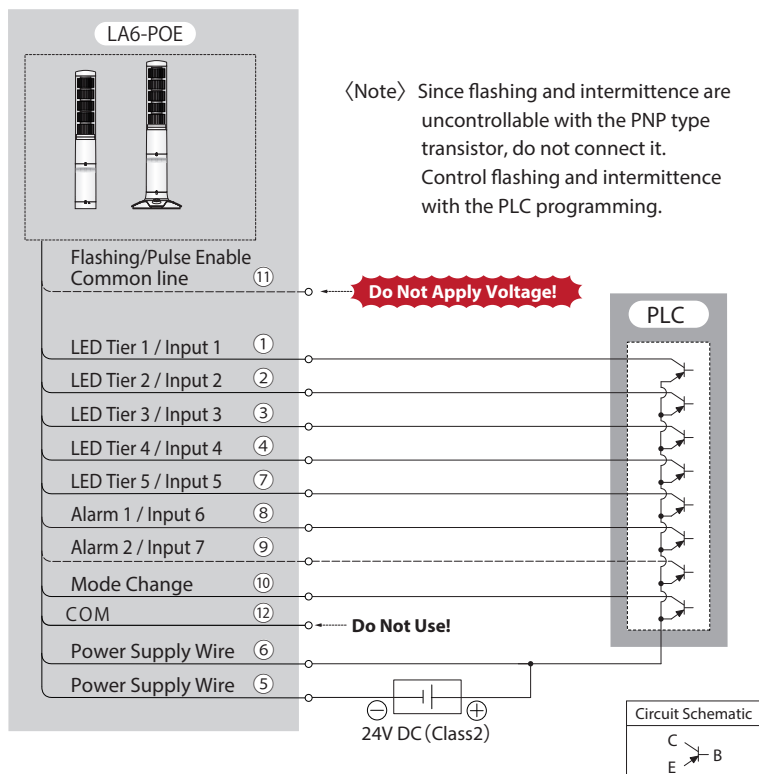

3.2.3.4. Connecting to Contact Relay with PoE Input

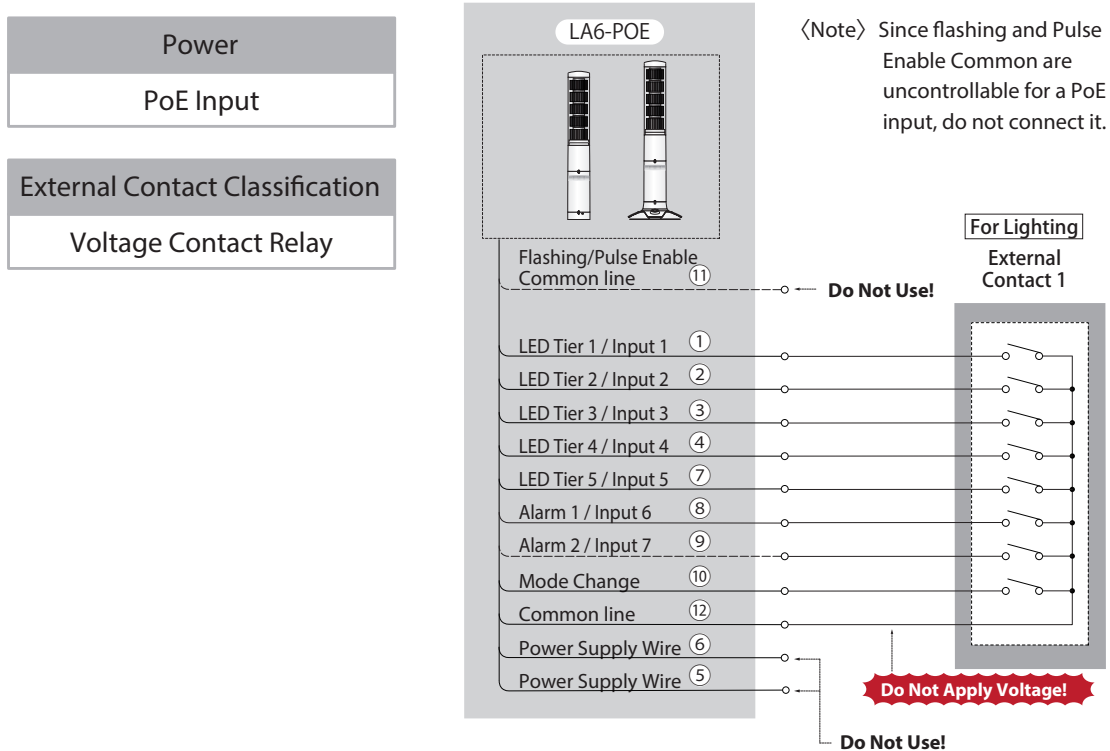

3.2.4. LAN Cable Connection

The LAN cable should be rated for category 5e or higher. A straight or cross cable can be used.

MEMO

- Be sure to use the IEEE802.3af compliant products for the PoE power feeder systems.
- Priority is given to the DC24V power source when both the DC24V power source and PoE power feeder systems are connected simultaneously.
- If both power sources are simultaneously connected, when disconnecting the DC24V source, this product may reboot.

3.3. Contact Capacity

Signal Wire Contact Capacity

Current Capacity	No more than 500 mA (DC24V) No more than 100 mA (PoE)
Withstand Voltage	DC 35V or greater
Leakage Current	0.1 mA or less
ON voltage (V_{sat})	Less than 1V

* Inrush current does not flow into the Mode Change line.

4. How to Operate

4.1. Operating Procedure

4.1.1. Controlling with Commands

- ① Set up the LA6-POE network.
 - Set the IP address for the network. (Refer to “4.3 Network Setup” on page 23)
- ② Set up the LED unit colors and combinations.
 - Use the data setup application to create the LED unit colors and combinations. (Refer to the help section in the data setup application.)
 - Use the Web Setup Screen to set up. (Refer to “4.4.2 WEB Setup” on page 26)
- ③ Load the Setup Data information into the LA6-POE.
 - Use the Web Setup Screen to load the data. (Refer to “4.4.1 Loading Setup Data” on page 24)
- ④ Set up the control method.
 - Use a command control system in the Main Unit to set up with. (Refer to “4.5 Main Unit Setup” on page 28)
- ⑤ Set up the receiving command protocols.
 - When controlled by PNS or PHN Commands:
 - Set up for receiving commands. (Refer to “4.6 Command Configuration” on page 29)
 - When being controlled by Modbus/TCP:
 - Set up for Modbus/TCP commands. (Refer to “4.7 Modbus/TCP Setup” on page 30)
 - Control with HTTP commands.
 - Set HTTP command reception settings. (Refer to “4.11 HTTP command receiving settings” on page 36)
- ⑥ Set up the contact inputs.
 - Set up the operation sequence for when an input occurs at the contact input. (Refer to “4.8 Contact Input Detection” on page 31)
 - * The contact inputs are: clear/mute/trigger/STOP

4.1.2. When Controlling with the Signal Line Inputs

- ① Set up the LA6-POE network.
 - Set the IP address for the network. (Refer to “4.3 Network Setup” on page 23)
- ② Set up the LED unit colors and combinations.
 - Use the data setup application to create the LED unit colors and combinations. (Refer to the help section in the data setup application.)
 - Use the Web Setup Screen to set up. (Refer to “4.4.2 WEB Setup” on page 26)
- ③ Load the Setup Data information into the LA6-POE.
 - Use the Web Setup Screen to load the data. (Refer to “4.4.1 Loading Setup Data” on page 24)
- ④ Set up the control method.
 - Use a command control system to set up with the signal lines. (Refer to “4.5 Main Unit Setup” on page 28)

- ⑤ Set up the receiving command protocols.
 - When acquiring status conditions by PNS or PHN Commands:
Set up for receiving commands. (Refer to "4.6 Command Configuration" on page 29)
 - When acquiring status conditions by Modbus/TCP:
Set up for Modbus/TCP commands. (Refer to "4.7 Modbus/TCP Setup" on page 30)
 - Get status with an HTTP command.
Set HTTP command reception settings. (Refer to "4.11 HTTP command receiving settings" on page 36)

4.1.3. When Mirroring

- ① Set up the LA6-POE network.
 - Set the IP address for the network. (Refer to "4.3 Network Setup" on page 23)
- ② Set up the LED unit colors and combinations.
 - Use the data setup application to create the LED unit colors and combinations.
(Refer to the help section in the data setup application.)
 - Use the Web Setup Screen to set up. (Refer to "4.4.2 WEB Setup" on page 26)
- ③ Load the Setup Data information into the LA6-POE.
 - Use the data setup application to load the data. (Refer to "4.4.1 Loading Setup Data" on page 24)
* Be sure to write the same information for the mirroring point and mirroring origin.
- ④ Mirroring Setup
 - Setup mirroring for the point of origin, establishing the "Master."
(Refer to "4.9.1 Setting up the Mirroring Source" on page 33)
 - Setup mirroring for the target point, establishing the "Slave."
(Refer to "4.9.2 Setup Mirroring Destination Point" on page 34)

4.1.4. When Collecting the Signal Tower Information

[Retrieving the Signal tower information submitted by a LA6-POE]

- ① Set up the LA6-POE network.
 - Set the IP address for the network. (Refer to "4.3 Network Setup" on page 23)
- ② Set up the LED unit colors and combinations.
 - Use the data setup application to create the LED unit colors and combinations.
(Refer to the help section in the data setup application.)
 - Use the Web Setup Screen to set up. (Refer to "4.4.2 WEB Setup" on page 26)
- ③ Load the Setup Data information into the LA6-POE.
 - Use the Web Setup Screen to load the data. (Refer to "4.4.1 Loading Setup Data" on page 24)
* When writing data using the USB cable, be sure to synchronize the data in the "Main unit setup" screen.
- ④ Set up the control method.
 - In the "Main Unit Setup" screen, set to the "Signal Wire control." (Refer to "4.5 Main Unit Setup" on page 28)
- ⑤ Set up the Signal Tower Information Transmission.
 - Set the receiver address. (Refer to "4.10 Information Transmission Setup" on page 35)
 - Configure the Signal Tower Input Judgment. (Refer to "4.10 Information Transmission Setup" on page 35)
 - Select the smart mode information to send. (Refer to "4.10 Information Transmission Setup" on page 35)

[Send a command to LA6-POE and collect information]

- ① Set up the LA6-POE network.
 - Set the IP address for the network. (Refer to "4.3 Network Setup" on page 23)
- ② Set up the LED unit colors and combinations.
 - Use the data setup application to create the LED unit colors and combinations. (Refer to the help section in the data setup application.)
 - Use the Web Setup Screen to set up. (Refer to "4.4.2 WEB Setup" on page 26)
- ③ Load the Setup Data information into the LA6-POE.
 - Use the Web Setup Screen to load the data. (Refer to "4.4.1 Loading Setup Data" on page 24)
 - * When loading data using the USB cable, be sure to synchronize the data in the "Main unit setup" screen.
- ④ Set up the control method.
 - In the "Main Unit Setup" screen, set to the "Signal Wire control." (Refer to "4.5 Main Unit Setup" on page 28)
- ⑤ Command receiving setup.
 - Set up for receiving commands. (Refer to "4.6 Command Configuration" on page 29)
- ⑥ Set up the Signal Tower Information Transmission.
 - Configure the Signal Tower Input Judgment. (Refer to "4.10 Information Transmission Setup" on page 35)

4.1.5. Disabling a function

[Disable Mirroring]

- ① Configure LA6-POE main unit.
 - Disable mirroring in the main unit settings. (Refer to "4.5 Main Unit Setup" on page 28)

[Disable Control by PNS and PHN Commands]

- ① Set LA6-POE command reception.
 - Disable command reception in the command reception settings. (Refer to "4.6 Command Configuration" on page 29)

[Disable Control by Modbus / TCP]

- ① Set Modbus / TCP for LA6-POE.
 - Disable Modbus / TCP in the Modbus / TCP settings. (Refer to "4.7 Modbus/TCP Setup" on page 30)

[Disable Control by HTTP Command]

- ① Set HTTP command reception settings for LA6-POE.
 - Disable HTTP command reception in the HTTP command reception settings. (Refer to "4.11 HTTP command receiving settings" on page 36)

4.2. Web Setup Screen

CAUTION

Be sure to change the network setup of the personal computer for the application as follows before communicating via a browser.
The personal computer IP address: 192.168.10.2-254
Subnet Mask: 255.255.255.0
(The default IP address at the time of factory shipment)

Once the power supply is switched on and startup is complete, enter the IP address of this product into the web browser address section.

The default IP address for this product is "192.168.10.1".

<Web Browser Input>

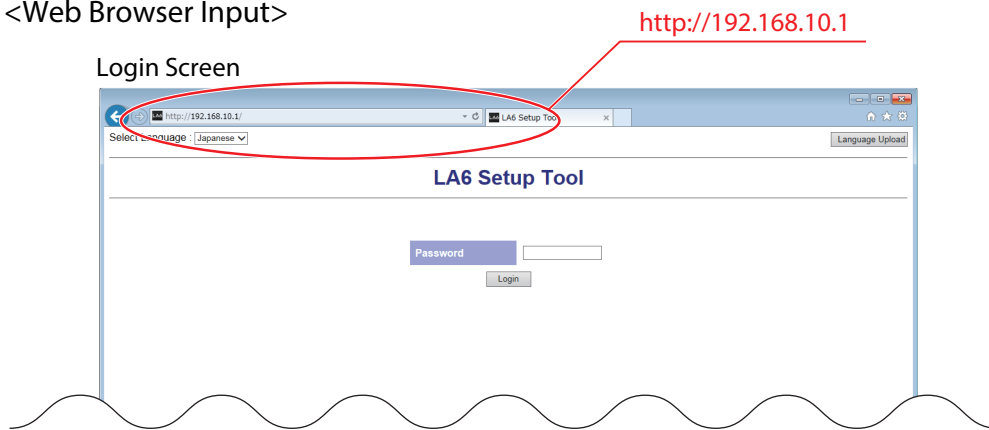

Recommended Browsers: Internet Explorer 11, Google Chrome, Microsoft Edge

Password setting screen displays upon first access or after the initialization process.

(Refer to "4.2.1 Set password" on page 21)

If password has already been set, the login screen will be displayed. (Refer to "4.2.2 Login" on page 22)

MEMO

The default password is "patlite", when using the LAN unit firmware for version 1.07 or earlier.
Be sure to change the password to prevent any security breaching.
Before use, please update your device to the latest firmware version.

4.2.1. Set password

Please set a password when accessing for the first time or when accessing after the initialization process. Login screen will be displayed after settings are complete.

MEMO

This setting screen does not display on the LAN unit firmware for version 1.07 or earlier.

	Item	Contents	Default Value	Input Parameter
①	password field	Enter password	<none>	Single-byte alphanumeric characters 1 to 16 characters
②	re-entry field	Enter the new password the same way in the re-entry field.	<none>	characters 1 to 16 characters
③	Set button	Password will be saved.	-	-
④	Menu to switch languages	Select desired language from the pull-down menu on the Web setting screen.	English	-
⑤	Language data update button	The uploaded language is displayed on the screen. (Refer to "6.7 Language Data Update" on page 94)	-	-

Follow the steps below to set the password. It will be used for subsequent logins.

[The method to change a password]

- ① Enter desired password in the password field.
- ② Enter the new password the same way in the re-entry field, to verify the password was entered correctly.
- ③ When the "Set" button is pushed, the entered value will be set as the new password.

Refer to "4.2.2. Login" on how to log in to the Web setting screen after completing the settings.

4.2.2. Login

Click the "Login" button after entering the password set in the Password field.

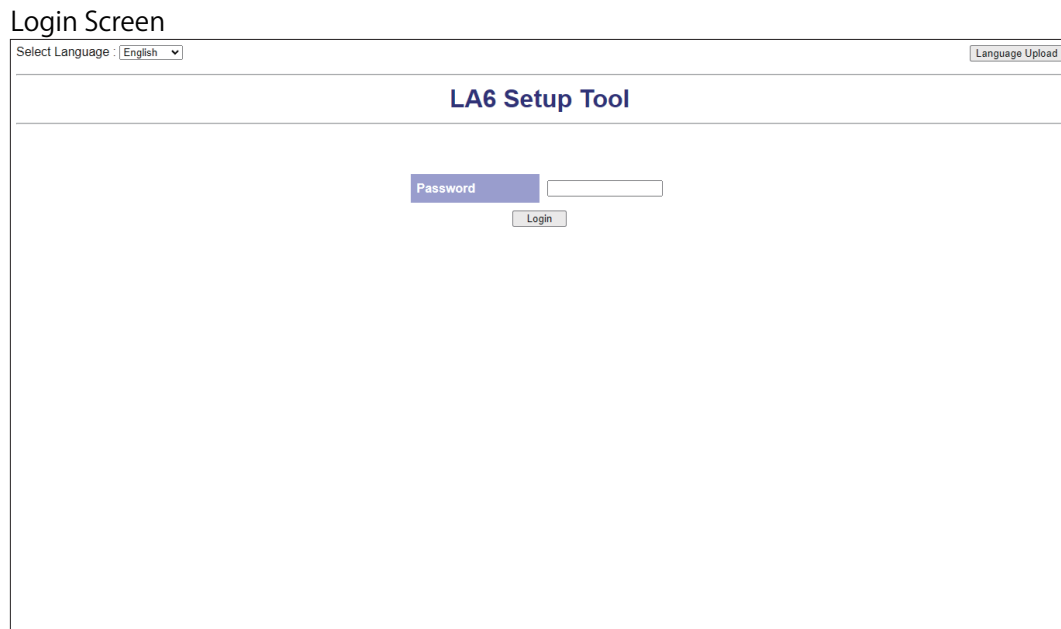

4.3. Network Setup

The network parameters for this product can be setup through a browser. The default IP address is "192.168.10.1". The items that can be set up through the System Setup Screen is as follows for "Network Setup."

If "Setup Automatically" is selected, this product can access a DHCP server to acquire network information.

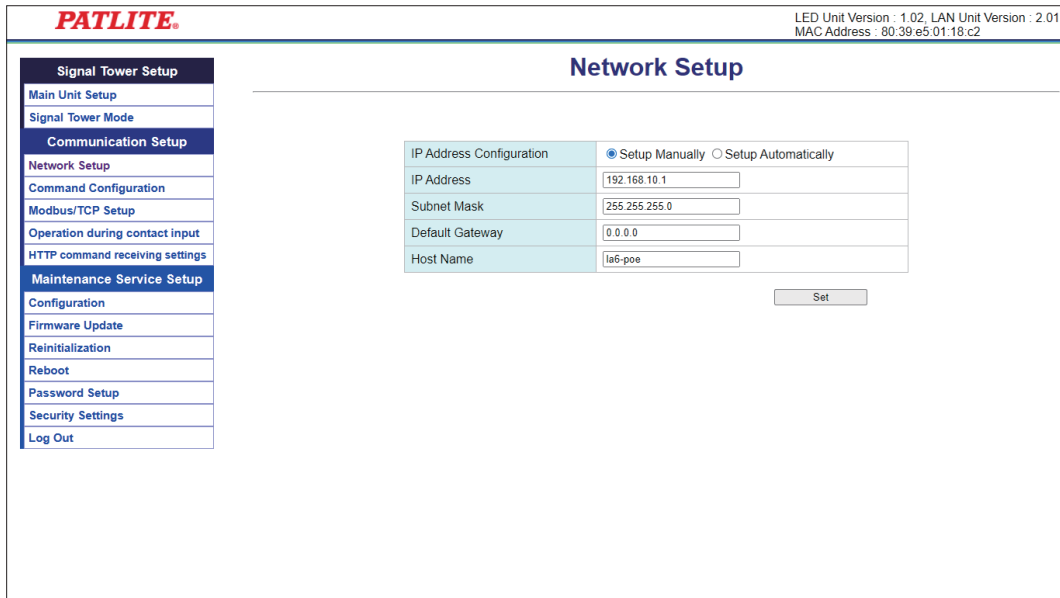

Network Setup

Item	Contents	Default Value	Input Parameter	Setup Option*1
IP Address Configuration Method	The method for setting up the IP address to this product as manual or automatic is selected.	Setup Manually	*	×
IP Address	Enter the IP address of this product.	192.168.10.1	IP Address Format	×
Subnet Mask	Enter the subnet mask of this product.	255.255.255.0	IP Address Format	×
Default Gateway	Enter the default gateway of this product.	0.0.0.0	IP Address Format	×
Host Name	Enter the Host name of this product	la6-poe	Host name max. 63 Characters *2	×

*1 The "Setup Option" indication is explained below to indicate in the diagram whether a value input is omissible (a blank is used) or not.

The "x" indicates where is not omissible, or is selected from an item menu.

*2 Register with a maximum of 63 single-byte alphanumeric characters (hyphens and periods can be included).

CAUTION

⚠ If the DHCP server cannot be accessed, the IP address, subnet mask, and default gateway will work by default.

MEMO

When the "Setup Automatically" is selected, the host name is notified to the DHCP server.

4.4. LED Unit Setup

This product can control the Signal Tower in two modes, Signal Tower mode and smart mode.

■ Signal Tower Mode

It is a mode to set the tone color of each LED tier and buzzer in advance for this product and control it by the signal line and commands.

■ Smart Mode

There are three types for the Smart Mode, "Time-trigger Type", "Pulse-trigger Type", and "Single-display Type":

- Time-trigger Type
The pattern transitions can be controlled in accordance to time.
- Pulse-trigger Type
The pattern transitions can be controlled in accordance to the trigger input.
- Single-display Type
The registered pattern is executed.

In each mode, every motion pattern is set in advance for this product and the pattern is executed in accordance to the signal line and command settings.

There are two ways to set up this product, writing and loading data that was set up, or using Web settings.

4.4.1. Loading Setup Data

The LED unit can be Setup from the "EDITOR for LA series". The set data can be written from the "Configuration" screen.

* For the Setup method, refer to the help section in the "EDITOR for LA series".

[Data writing method in Web Setting]

In "Write LED Unit Setup Data", the data is selected in the "EDITOR for LA series".

The "Write" button is clicked to update the LED unit Settings. It reboots automatically after updating.

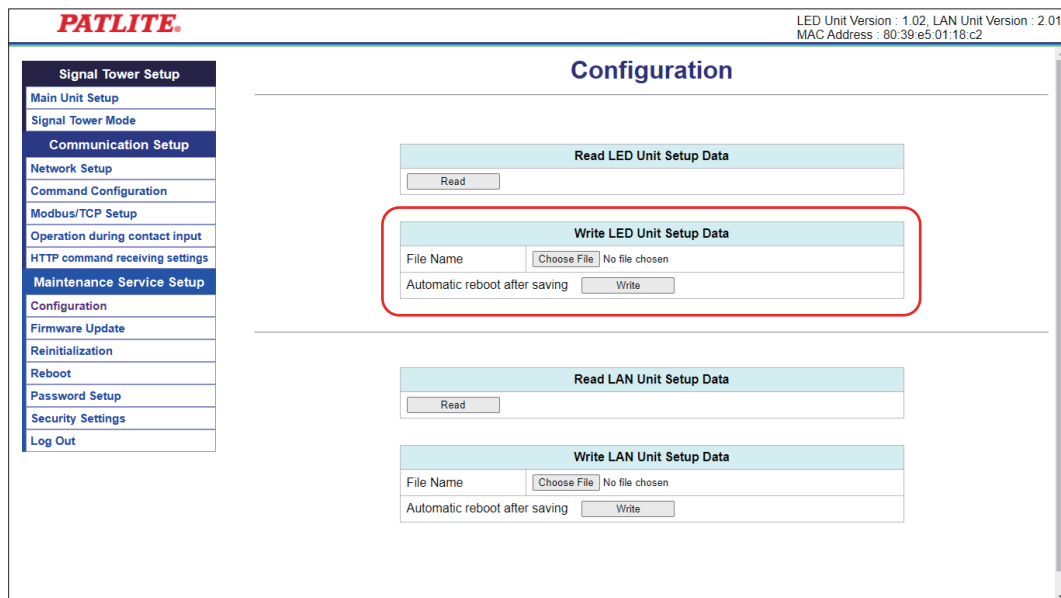

[Data writing method in "EDITOR for LA series"]

- ① The product changes to standby status (all signal inputs OFF).
(Power supply input can be ON or OFF, whichever is easier)
- ② Open the USB cover to the product, use the MicroUSB cable to connect the product to the personal computer.

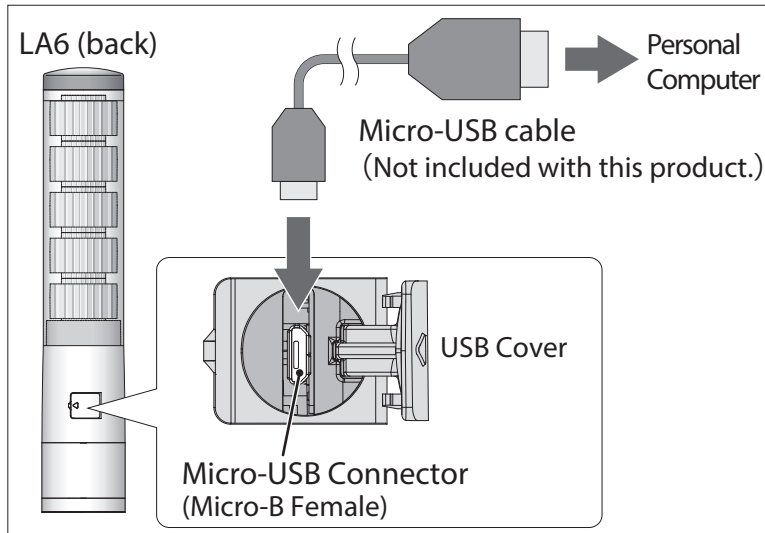

- ③ Click the "Send" button for the "EDITOR for LA series".
- ④ From the start of data transfer, it takes about 15 seconds before the "Transfer was completed" prompt is displayed.
- ⑤ Remove the micro-USB cable and close the USB cover completely.

⚠ WARNING

- When transferring data via USB connection, do not allow the supply voltage from this product to contact with the personal computer, or its peripheral devices. Failure to comply will result in product damage due to combustion or fire.
As an example, if the positive power terminal is connected to ground and the personal computer FG (housing), which in turn, makes a connection with this product via the USB connection, it should not be grounded because of the reverse polarity.
There are some personal computers which have the USB port connector and negative terminal of the personal computer in contact with the FG (housing).
Personal computers with such USB connections made, should have the FG (housing) of the personal computer and the negative terminal of the USB port of the product connected.
If the case is where the personal computer has the metal chassis as the positive grounding of the supplied power source to the product, the product will have a 24V potential applied to the negative terminal of the USB port of the product, thus will damage product by burning-up.

⚠ NOTICE

- ⓘ When acquiring the Signal Tower Information, click the "Sync" button in Main Unit Setup after writing data.

4.4.2. WEB Setup

On the "Signal Tower Mode" screen, select the LED lighting color, buzzer sound and flashing speed.

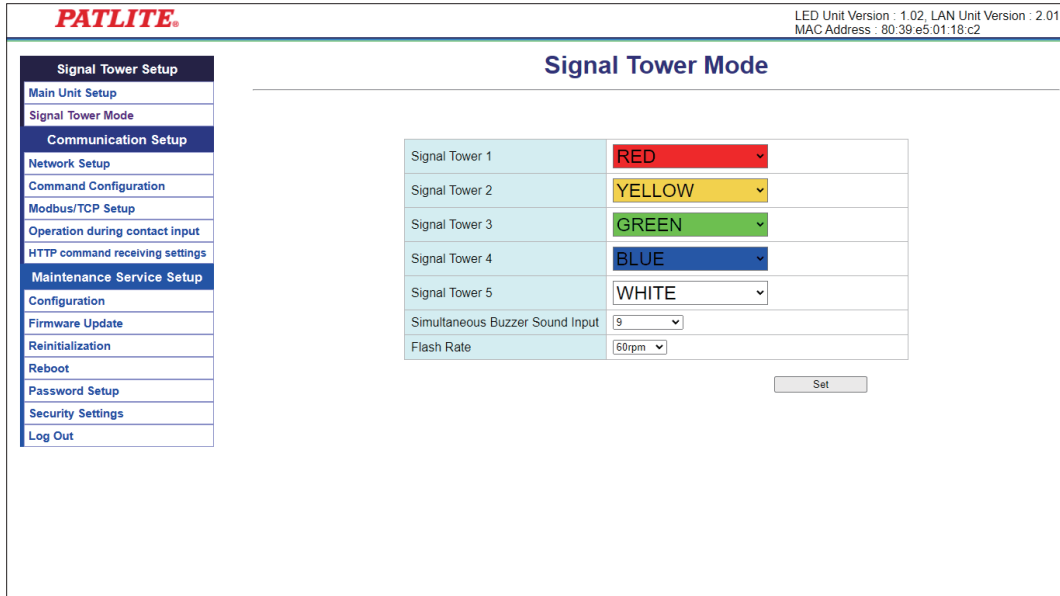

Item	Contents	Default Value	Input Parameter	Setup Option
Signal Tower 1	Select among: BLACK, RED, YELLOW, LEMON, GREEN, SKYBLUE, BLUE, PURPLE, PINK, WHITE	RED	-	×
Signal Tower 2		YELLOW	-	×
Signal Tower 3		GREEN	-	×
Signal Tower 4		BLUE	-	×
Signal Tower 5		WHITE	-	×
Buzzer (At simultaneous buzzer inputs)	Select among patterns 0-11.	9	-	×
Flashing Cycle (Flash per Minute = fpm)	Selections are for Lighting: 30 fpm: 60 fpm: 120 fpm	60/fpm	-	×

* Only the Signal Tower mode can be set up in the WEB Setup.

To set up the Smart Mode, use the "EDITOR for LA series".

For the Setup method, refer to the help section in the "EDITOR for LA series".

* The "Setup Option" indication is explained below to indicate in the diagram whether a value input is omissible (a blank is used) or not.

The "x" indicates where is not omissible, or is selected from an item menu.

MEMO

- The tier where BLACK is selected will not light up.
- When 0 is selected, the buzzer will not sound at the same time.
- Reboots automatically after the setup changes.

4.4.3. Read Setup Data

The setting data for this product can be read. There are two types of data which can be read, the LED unit setting data and LAN unit setting data.

<<Reading the setting data of the LED unit>>

Click the "Read" button for reading the LED unit setting data and save it on a personal computer. The setting data of the read LED unit can be written to another LA6-POE, and the contents can be checked with the "EDITOR for LA series".

<<Reading the setting of the LAN unit>>

Click the "Read" button of the LAN unit setting data readout and save it on a personal computer. The setting data of the read LAN unit can be written to another LA6-POE.

The screenshot shows the PATLITE Configuration web interface. On the left is a navigation menu with categories like Signal Tower Setup, Communication Setup, Network Setup, Maintenance Service Setup, and Configuration. The main area is titled 'Configuration' and contains four sections: 'Read LED Unit Setup Data' with a 'Read' button; 'Write LED Unit Setup Data' with a 'File Name' field, a 'Choose File' button, and a 'Write' button; 'Read LAN Unit Setup Data' with a 'Read' button; and 'Write LAN Unit Setup Data' with a 'File Name' field, a 'Choose File' button, and a 'Write' button. The top right corner displays 'LED Unit Version : 1.02, LAN Unit Version : 2.01' and 'MAC Address : 80:39:e5:01:18:c2'.

MEMO

When reading the setting data of the LED unit, turn off all signal line inputs and do not perform mirroring.

CAUTION

⚠ Sending a command while reading the LED unit setting data will not work.

4.5. Main Unit Setup

The buzzer volume and the control method can be set up.
The LED unit setup data can be synchronized.

Item	Contents	Default Value	Input Parameter	Setup Option
Buzzer Sound	Select among 0 (Mute), 1, 2, and 3 (Maximum).	3 (Maximum)	-	×
Control-system Switchover	Select among "Command Control" and "Signal Wire Control".	Command Control	-	×
Mirroring reception	Select to enable or disable mirroring reception.	Enabled	-	×

* The "Setup Option" indication is explained below to indicate in the diagram whether a value input is omissible (a blank is used) or not.

The "x" indicates where is not omissible, or is selected from an item menu.

MEMO

- When 0 (Mute) is set, the buzzer won't sound.
- When the command control method is selected, the LED unit can not be controlled by the signal line input.
- When the signal line control method is selected, control can not be done by commands. Only status acquisition and reboot is possible.
- Reboots automatically after the setup changes.
- Click "Sync" button when writing setup data using usb cable.

4.6. Command Configuration

Set up for receiving PNS and PHN Commands.

[Setup Method]

- ① Select either "TCP" or "UDP" in "Protocol."
- ② Enter the port to be used for "Port Number."
- ③ Click the "Set" button to apply the setting.

Item	Contents	Default Value	Input Parameter	Setup Option
Command Configuration	Select to enable or disable Command Configuration.	Enabled	-	×
Protocol	Select between TCP or UDP.	TCP	-	×
Port Number	Enter the receiving port number.	10000	Single-byte numbers from 10000-65535*	×

* The same port number as Modbus/TCP, and 60001-60008, 61001 cannot be set.

* The "Setup Option" indication is explained below to indicate in the diagram whether a value input is omissible (a blank is used) or not.

The "x" indicates where is not omissible, or is selected from an item menu.

MEMO

- PNS Commands (Refer to "5.1. PNS Command")
- PHN Commands (Refer to "5.2. PHN Command")

4.7. Modbus/TCP Setup

Set the port number to be used in Modbus/TCP.

[Setup Method]

- ① Enter the port to be used for "Port Number."
- ② Click the "Set" button to apply the settings.

Item	Contents	Default Value	Input Parameter	Setup Option
Modbus / TCP Setup	Select Enable / Disable Modbus / TCP.	Enabled	-	×
Port Number	Enter the port number.	502	Single-byte digit 502, Or 1024-65535*	×

* The same port number as the command reception function, and 60001-60008, 61001 cannot be set.

* The "Setup Option" indication is explained below to indicate in the diagram whether a value input is omissible (a blank is used) or not.

The "x" indicates where is not omissible, or is selected from an item menu.

MEMO

Modbus/TCP Command (Refer to "5.3. Modbus/TCP")

4.8. Contact Input Detection

It detects the status change of the contact input and perform the set-up process.
The setup for the contact input detection is done in the Web Setup.

- ① Set the action to be executed when the setting input status 1 to 4 changes.
- ② Press the "Set" button to apply the settings.

MEMO

Only when the command control method is selected, the operation screen is displayed during contact input.

The contents that operates for each contact input can be selected.

Select Operation	Operation Contents	Available Modes
No action	Even if contact input is turned ON/OFF, it will not operate.	-
Clear	When the contact input is turned ON, clearing is executed. Nothing will operate when it is OFF.	Signal Tower Mode Smart Mode (Single-display, Time-trigger, Pulse-trigger)
Mute	While the contact input is turned on, Mute is ON. While the contact input is turned off, Mute is OFF.	Smart Mode (Single-display, Time-trigger, Pulse-trigger)
STOP	While the contact input is turned on, STOP is turned ON. While the contact input is turned off, STOP is OFF.	Smart Mode (Time-trigger, Pulse-trigger)
Trigger Input	While the contact input is turned on, the pulse trigger is turned ON. Nothing will operate when it is OFF.	Smart Mode (Pulse-trigger)

[Table of Available Modes]		Signal Tower Mode	Smart Mode		
			Single-display	Time-trigger	Pulse-trigger
Operation	Clear	OK	OK	OK	OK
	Mute	No	OK	OK	OK
	STOP	No	No	OK	OK
	Trigger Input	No	No	No	OK

MEMO

- When it is not in an available mode, even if the contacts operate, it won't operate.
- The Mute and STOP can only be controlled in Smart Mode.

4.9. Mirroring Setup

This section explains how to configure Mirroring settings.

[Mirroring Source Settings]

1	Attach the lead wires.	"3.2. Wiring" on page 13
2	Attach the LAN cable.	
3	Display the "Main Unit Setup" screen.	"4.9.1. Setting up the Mirroring Source" on page 33
4	Set to the "Signal Wire Control".	
5	Display the "Mirroring Set up" screen.	
6	Register the IP address of mirroring destination.	

[Mirroring Destination Point Settings]

1	Attach the LAN cable.	"3.2. Wiring" on page 13
2	Display the "Main Unit Setup" screen.	"4.9.2. Setup Mirroring Destination Point" on page 34
3	Set to the "Command Control".	

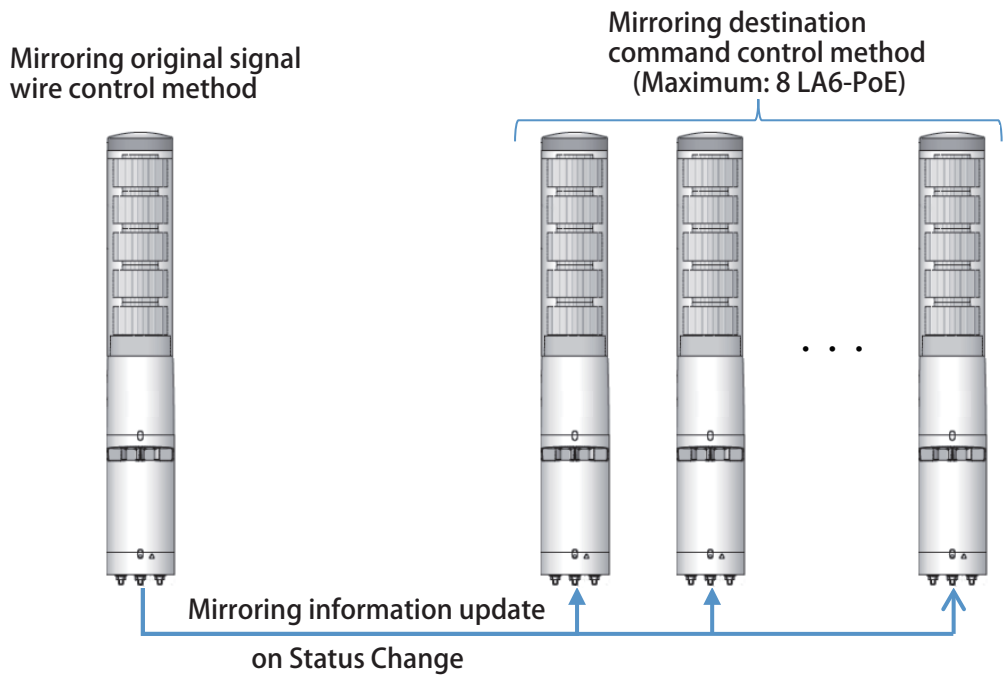

Up to **nine** LA6-POE Signal Towers can be in the same status by sending the status of the LA6-POE which is being controlled by the Master via the signal line, to another **one of eight** LA6-POE Signal Towers connected within the network. The maximum possible number of mirrored LA6-POE Signal Towers is **eight units**. Mirroring information is updated when the status changes. Even if status does not change, the mirroring information is updated every 10 seconds.

4.9.1. Setting up the Mirroring Source

In the "Main Unit Setup" screen, set the Control-system Switchover to the signal wire control method.

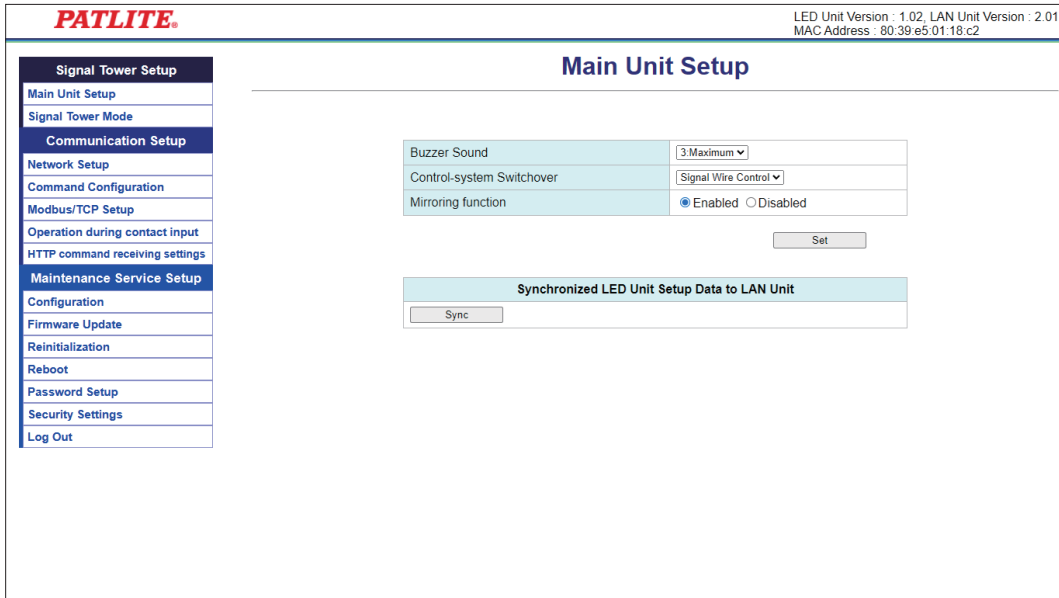

Register the IP address of the mirroring destination in the "Mirroring Setup" screen.

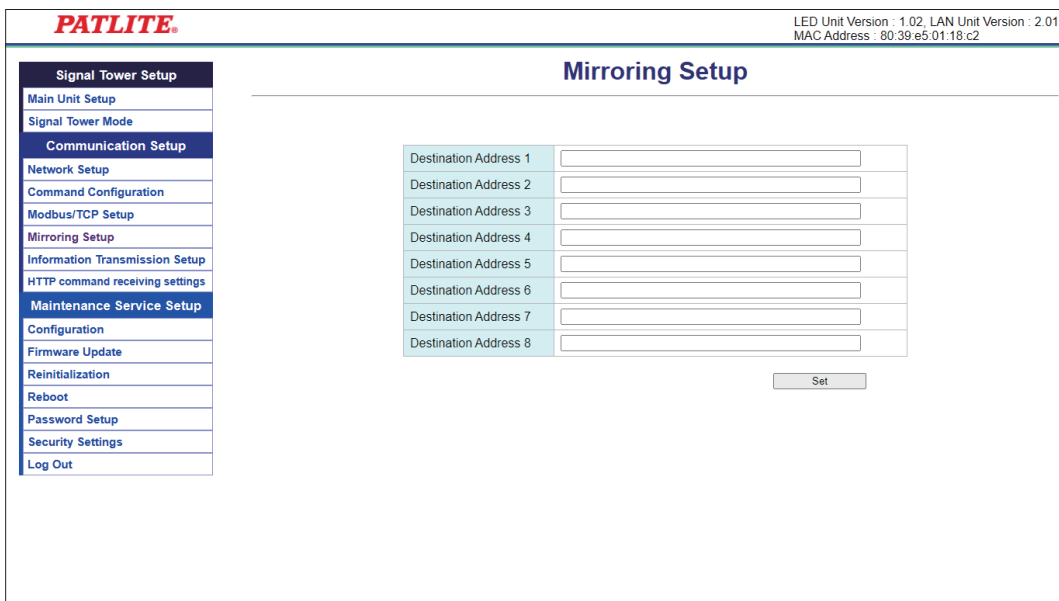

CAUTION

⚠ Set a different IP address for the destination address.

4.9.2. Setup Mirroring Destination Point

In the "Main Unit Setup" screen, set the control method to the command control method.

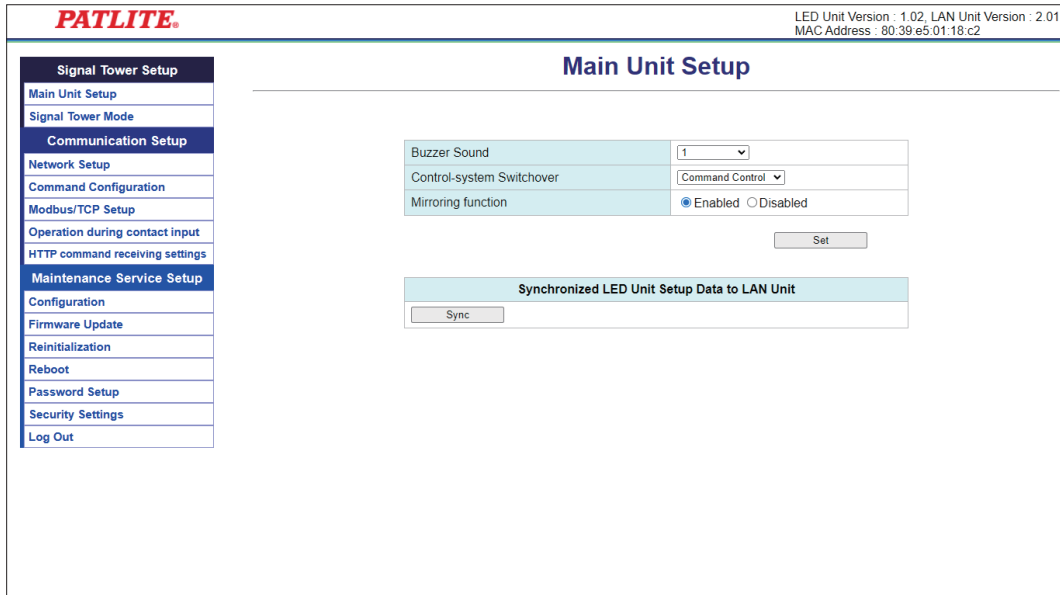

CAUTION

⚠ To mirror, set the same LED unit in the mirroring source and mirroring destination.
"4.4. LED Unit Setup" on page 24

4.10. Information Transmission Setup

Set the Destination Address of the signal tower information, signal tower input judgment,smart-mode information to send.

1	Attach the lead wires.	"3.2. Wiring" on page 13
2	Attach the LAN cable.	
3	Display the "Main Unit Setup" screen.	"4.5. Main Unit Setup" on page 28
4	Set to the "Signal Wire Control".	
5	Display the "Information Transmission Setup" screen.	On this page
6	Enter the IP address and port number to transmit Signal Tower Information	
7	Select Smart-mode information to send.	
8	Select Signal Tower input judgment.	

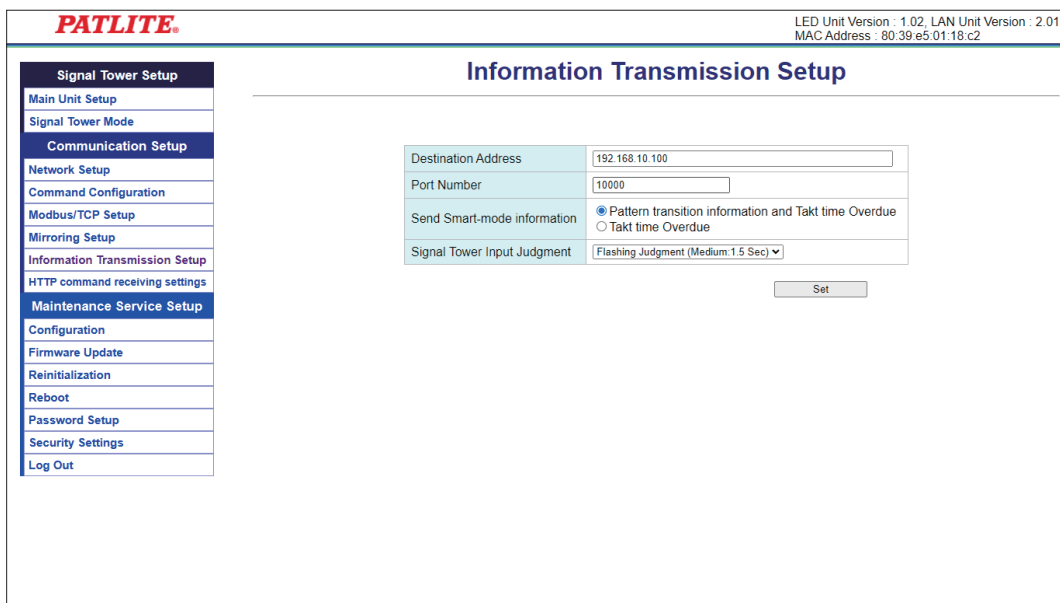

Item	Contents	Default Value	Input Parameter
Destination Address	Enter the destination IP address of Signal Tower Information.	<none>	IP Address Format
Port Number	Enter the destinatio Port Number of Signal Tower Information.	10000	1024-65535
Send Smart-mode information	Select the transmitted infromation when operating in Smart Mode. <Pattern transition information > Every time a pattern transition, send the Signal Tower information. <Takt time Overdue> When the takt time overdue,send the Signal Tower information.	Takt time Overdue	-
Signal Tower input judgment	Select the process used to determine the Signal Tower input status. <Normal Judgement> Flashing is not determined. <Flashing Judgment (Short : 0.7 Sec) > Flashing is determined when there are two status changes within 0.7 seconds. <Flashing Judgment (Medium : 1.5 Sec) > Flashing is determined when there are two status changes within 1.5 seconds. <Flashing Judgment (Long : 2.5 Sec) > Flashing is determined when there are two status changes within 2.5 seconds.	Medium	-

4.11. HTTP command receiving settings

Settings for receiving HTTP commands.

[Setup Method]

- ① Select either "Enable" or "Disable" in "User Authentication Settings".
- ② If "Enabled" is selected in ①, enter the user name to be authenticated in "Username".
- ③ If "Enabled" is selected in ①, enter the password to be authenticated with "Password".
- ④ Click the "Settings" button to apply the settings.

The screenshot shows the PATLITE web interface for "HTTP command receiving settings". At the top right, it displays "LED Unit Version : 1.02, LAN Unit Version : 2.01" and "MAC Address : 80:39:e5:01:18:c2". The left sidebar lists various setup options, with "HTTP command receiving settings" selected. The main content area has a title "HTTP command receiving settings" and a radio button selection for "Enabled" (selected) and "Disabled". Below this is a "User authentication settings" section with radio buttons for "Enabled" and "Disabled" (selected). A table follows with 8 rows, each having "Username" and "Password" columns. A "Set" button is located at the bottom right of the table.

Item	Contents	Default Value	Input Parameter
HTTP command receiving settings	Select to enable or disable the HTTP command reception function.	Enabled	-
User authentication settings	Select to enable or disable user authentication.	Disabled	-
Username	Enter the Username to be authenticated.	<none>	Alphanumeric characters, hyphens, periods up to 16 characters
Password	Enter the Password to be authenticated.	<none>	Alphanumeric characters, underscores, hyphens, periods, up to 16 characters

⚠ CAUTION

- ⚠ The user name cannot be set more than once.
- ⚠ Cannot set only the user name or password.

5. Operating Procedure

5.1. PNS Command

By sending PNS commands from a PC etc., you can control and obtain the status of this product. The protocol can be selected from "TCP" or "UDP."

Communication port numbers are "10000-65535."

MEMO

- The PNS command setup can be executed with the command reception setting. (Refer to "4.6. RSH Command Configuration.")
- The number of simultaneous connections with a PNS Command and PHN Command is 8 connections.

Identifier List

Identifiers	Command Name	Outline
T(54H)	Smart Mode Control	Execute the Smart Mode.
M(4DH)	Mute	Switches the buzzer ON/OFF when operating in Smart Mode.
P(50H)	STOP/Pulse Input	An input can be entered in the Smart Mode operation. Time-trigger Type Operation: STOP Input ON/OFF Pulse-trigger Type Operation: Pulse Trigger Input
S(53H)	Motion Control	Control 1-5 tiers of the LED unit with a set color.
D(44H)	Detailed Motion Control	Control 1-5 tiers of the LED unit by specifying the color.
C(43H)	Clear	Turn off the LED unit. Stop the buzzer.
B(42H)	Reboot	This product is rebooting.
G(47H)	Status Acquisition	The status of this machine is acquired.
E(45H)	Detailed Status Acquisition	The detailed status of this machine can be acquired.
F(46H)	Individual flashing control	Detailed flashing is controlled individually for each tier.

Below are the parameters that can be controlled by each control method.

Identifiers	Command Name	Command Control	Signal Wire Control
T(54H)	Smart Mode Control	●	×
M(4DH)	Mute	●	×
P(50H)	STOP/Pulse Input	●	×
S(53H)	Motion Control	●	×
D(44H)	Detailed Motion Control	●	×
C(43H)	Clear	●	×
B(42H)	Reboot	●	●
G(47H)	Status Acquisition	●	●
E(45H)	Detailed Status Acquisition	●	●
F(46H)	Individual flashing control	●	×

5.1.1. Smart Mode Control Command

Command Description

The Smart Mode can be executed with the number specified in the data area.

Transmission Data Format

Product Category AB		Identifier T	Open	Data Size		Data Area 1 byte
41H	42H	54H	00H	00H	01H	See Below

Product Category

The product is classified in "AB."

Identifiers

"T" is used.

Data Area

Data area byte: 1Byte
01H (Group No. 1)- 1FH (Group No. 31)

Reply Data

Normal Response (1 byte)

ACK
06H

Abnormal Response (1 byte)

NAK
15H

Command Transmission Example

Smart Mode group 10 is executed.

Product Category AB		Identifier T	Open	Data Size		Data Area 1 byte
41H	42H	54H	00H	00H	01H	0AH

MEMO

- When executing Single-display type, or group No., up to 31 (01H-1FH) can be designated.
- To execute the Time-trigger type or Pulse-trigger type, up to 15 (01H - 0FH) groups can be specified when setting up.

5.1.2. Mute Command

Command Description

The ON/OFF of the buzzer is controllable when executing in Smart Mode.

Transmission Data Format

Product Category AB		Identifier M	Open	Data Size		Data Area 1 byte
41H	42H	4DH	00H	00H	01H	See Below

Product Category

The product is classified in "AB."

Identifiers

"M" is used.

Data Area

Data area byte: 1Byte
Mute ON: 01H
Mute OFF: 00H

Reply Data

Normal Response (1 byte)

ACK
06H

Abnormal Response (1 byte)

NAK
15H

Command Transmission Example

Turn Mute ON.

Product Category AB		Identifier M	Open	Data Size		Data Area 1 byte
41H	42H	4DH	00H	00H	01H	01H

CAUTION

 When set to ON with the MUTE command, the buzzer will be muted until the MUTE is turned off.

MEMO

- It is effective only during the Smart mode operation.
- When a "Clear" command is received or the "Clear" button is pressed, mute is also turned OFF.
- If it is being controlled by anything other than Smart mode, the Mute and STOP will be OFF.

5.1.3. STOP/Pulse Input Command

Command Description

When transmitting during the Time-trigger mode operation, the pattern stop/restart can be controlled. (STOP Input)

When transmitting during the Pulse-trigger mode operation, the pattern can be changed. (Pulse Trigger Input)

Transmission Data Format

Product Category AB		Identifier P	Open	Data Size		Data Area 1 byte
41H	42H	50H	00H	00H	01H	See Below

Product Category

The product is classified in "AB."

Identifiers

"P" is used.

Data Area

Data area byte: 1Byte
STOP input ON/Pulse Trigger input: 01H
STOP Input OFF: 00H

Reply Data

Normal Response (1 byte)

ACK
06H

Abnormal Response (1 byte)

NAK
15H

Command Transmission Example

A trigger input is executed.

Product Category AB		Identifier P	Open	Data Size		Data Area 1 byte
41H	42H	50H	00H	00H	01H	01H

CAUTION

⚠ If the STOP input is set to ON with the STOP/Pulse Input Command, the pattern will stop until STOP is turned off.

MEMO

- It is effective only during the Smart mode operation.
- When a "Clear" command is received or the "Clear" button is pressed, STOP is also turned OFF.
- If it is being controlled by anything other than Smart mode, the STOP will be OFF.

5.1.4. Managing Command Control

Command Description

Each LED unit tier and buzzer (1-3) can be controlled with the pattern specified in the data area. It operates with the color and buzzer set up in the Signal Tower mode.

Transmission Data Format

Product Category AB		Identifier S	Open	Data Size		Data Area 6 bytes
41H	42H	53H	00H	00H	06H	See Below

Product Category

The product is classified in "AB."

Identifiers

"S" is used.

Data Area

Data Area 6 bytes					
LED Unit					Buzzer
1	2	3	4	5	6
Tier 1 Pattern	Tier 2 Pattern	Tier 3 Pattern	Tier 4 Pattern	Tier 5 Pattern	Patterns 1,2,3

LED Unit
00H: Off
01H: On
02H: Flashing
09H: No Change

Buzzer
00H: Stop
01H: Pattern 1
02H: Pattern 2
03H: Buzzer sound at a simultaneous buzzer input
09H: No Change

Command Transmission Example

1st Tier: lighting, 2nd tier/3rd tier: flashing, 4th tier: Off, 5th tier: no change, buzzer: pattern 1

Product Category AB		Identifier S	Open	Data Size		Data Area					
41H	42H	53H	00H	00H	06H	01H	02H	02H	00H	09H	01H

Reply Data

Normal Response (1 byte)

ACK
06H

Abnormal Response (1 byte)

NAK
15H

5.1.5. Managing Detailed Command Control

Command Description

In the data area, the color and behavior pattern of each LED unit tier and buzzer pattern (1 to 11) can be controlled when being specified.

Transmission Data Format

Product Category AB		Identifier D	Open	Data Size			Data Area 7 bytes					
41H	42H	44H	00H	00H	07H	See Below						

Product Category

The product is classified in "AB."

Identifiers

"D" is used.

Data Area

Data Area 7 bytes						
LED Unit					Flashing Operation	Buzzer
1	2	3	4	5	6	7
Tier 1 Color	Tier 2 Color	Tier 3 Color	Tier 4 Color	Tier 5 Color	Flashing Operation	Patterns 1-11

LED Unit
00H: Off
01H: Red
02H: Amber
03H: Lemon
04H: Green
05H: Sky Blue
06H: Blue
07H: Purple
08H: Pink
09H: White

Flashing Operation
00H: Flashing OFF
01H: Flashing ON

Buzzer
00H: Stop
01H: Pattern 1
02H: Pattern 2
03H: Pattern 3
04H: Pattern 4
05H: Pattern 5
06H: Pattern 6
07H: Pattern 7
08H: Pattern 8
09H: Pattern 9
0AH: Pattern10
0BH: Pattern 11

Reply Data

Normal Response (1 byte)

ACK
06H

Abnormal Response (1 byte)

NAK
15H

Command Transmission Example

1st Tier : Green, 2nd Tier: Blue, 3rd Tier: Off, 4thTier: White, 5th Tier: Red, Flashing: Off, Buzzer: Pattern 11

Product Category AB		Identifier D	Open	Data Size			Data Area					
41H	42H	44H	00H	00H	07H	04H	06H	00H	09H	01H	00H	0BH

MEMO

- The color set in the signal Tower mode becomes invalid.
- When the flashing operation is turned ON, all tiers will flash.

5.1.6. Clear Command

Command Description

Turn off the LED unit and stop the buzzer.

Transmission Data Format

Product Category AB		Identifier C	Open	Data Size		
41H	42H	43H	00H	00H	00H	

Product Category

The product is classified in "AB."

Identifiers

"C" is used.

Data Area

There is no data area.

Reply Data

Normal Response (1 byte)

ACK
06H

Abnormal Response (1 byte)

NAK
15H

5.1.7. Reboot Command

Command Description

This product can be rebooted.

Transmission Data Format

Product Category AB		Identifier B	Open	Data Size		Data Area 1-16 bytes
41H	42H	42H	00H	00H	01H-10H	See Below

Product Category

The product is classified in "AB."

Identifiers

"B" is used.

Data Size

Enter the number of bytes for the data area.

When the value is "patlite".

00H	07H
-----	-----

Data Area

Enter the ASCII code for the first access or the password set in the password settings in the Web settings.

Reply Data

Normal Response (1 byte)

ACK
06H

Abnormal Response (1 byte)

NAK
15H

Command Transmission Example

When the password is set to "patlite".

Product Category AB		Identifier B	Open	Data Size		Data Area						
						p	a	t	l	i	t	e
41H	42H	42H	00H	00H	07H	70H	61H	74H	6CH	69H	74H	65H

5.1.8. Status Acquisition Command

Command Description

The status of the signal line/contact input, the LED unit and buzzer status can be acquired.

Transmission Data Format

Product Category AB		Identifier G	Open	Data Size	
41H	42H	47H	00H	00H	00H

Product Category

The product is classified in "AB."

Identifiers

"G" is used.

Data Area

There is no data area.

Reply Data

Normal Response (15 bytes): When running in Signal Tower Mode

1 byte	2 bytes	3 bytes	4 bytes	5 bytes	6 bytes	7 bytes	8 bytes
Input 1	Input 2	Input 3	Input 4	Input 5	Input 6	Input 7	Input 8
00H: OFF 01H: ON							

9 bytes	10 bytes	11 bytes	12 bytes	13 bytes	14 bytes	15 bytes
Mode	LED unit/buzzer Status					
	1st Tier	2nd Tier	3rd Tier	4th Tier	5th Tier	Buzzer
00H (Signal Tower mode)	00H: Off 01H: On 02H: Flashing					00H: Stop 01H: Buzzer Pattern 1 02H: Buzzer Pattern 2 03H: Buzzer Pattern 3/ buzzer sounds when the buzzer inputs are simultaneously entered (Cont) 0AH: Buzzer pattern 10 0BH: Buzzer pattern 11

Normal Response (15 bytes): When running in Smart mode

1 byte	2 bytes	3 bytes	4 bytes	5 bytes	6 bytes	7 bytes	8 bytes
Signal line/contact status							
Input 1	Input 2	Input 3	Input 4	Input 5	Input 6	Input 7	Input 8
00H: OFF 01H: ON							

9 bytes	10 bytes	11 bytes	12 bytes	13 bytes	14 bytes	15 bytes
Mode	Smart Mode Status					
	Group Number	Mute	STOP Input	Pattern Number	Open	Open
01H (Smart Mode)	01H: Group 1 02H: Group 2 (Cont) 1EH: Group 30 1FH: Group 31	00H: Mute Off 01H: Mute ON	00H: STOP OFF 01H: STOP ON	01H: Group 1 02H: Group 2 (Cont) 3EH: Group 62 3FH: Group 63	00H	00H

Abnormal Response (1 byte)

NAK
15H

Command Response Example

Conditions are; Inputs 1, 3, 5, and 8 are ON, smart mode group number: 5, mute input: ON, STOP input: OFF, pattern number: 15.

1 byte	2 byte	3 byte	4 byte	5 byte	6 byte	7 byte	8 byte	9 byte	10 byte	11 byte	12 byte	13 byte	14 byte
Signal line/Contact Status								Smart Mode Status					
Input 1	Input 2	Input 3	Input 4	Input 5	Input 6	Input 7	Input 8	Group Number	Mute	STOP Input	Pattern Number	Open	Open
01H	00H	01H	00H	00H	01H	00H	01H	05H	01H	00H	0FH	00H	00H

MEMO

- When in the signal light mode operation (input 8 is OFF), the signal line/contact and LED unit/buzzer returns to its status.
- In smart mode operation (input 8 is ON), it returns to the smart mode status.
- When multiple buzzer patterns are ON simultaneously, Buzzer Pattern 3 is prioritized.
- Up to 11 buzzer patterns can acquired during managing detailed command control.

5.1.9. Detailed Status Acquisition Command

Command Description

The following information can be acquired.

- The status of the signal line/contact input.
- The LED unit status.
- The LED unit color information.
- The MAC address of this product.

Transmission Data Format

Product Category AB		Identifier E	Open	Data Size	
41H	42H	45H	00H	00H	00H

Product Category

The product is classified in "AB."

Identifiers

"E" is used.

Data Area

There is no data area.

Reply Data

[Normal Response (40 bytes): When running in Signal Tower Mode]

1 byte	2 bytes	3 bytes	4 bytes	5 bytes	6 bytes	7 bytes	8 bytes	9 bytes	10 bytes	11 bytes	12 bytes	13 bytes	14 bytes
MAC address						Input 1	Input 2	Input 3	Input 4	Input 5	Input 6	Input 7	Input 8
The MAC address of this product is stored.						00H: OFF 01H: ON							
15 bytes		16 bytes	17 bytes	18 bytes	19 bytes	20 bytes		21 bytes	22 bytes	23 bytes			
Mode		Open				1st Tier of LED unit							
						Status		R	G	B			
00H (Signal Tower mode)		00H	00H	00H	00H	00H: Off 01H: On 02H: Flashing		00H-FFH	00H-FFH	00H-FFH			
24 bytes		25 bytes	26 bytes	27 bytes	28 bytes	29 bytes	30 bytes	31 bytes					
2nd Tier of LED unit					3rd Tier of LED unit								
Status		R	G	B	Status		R	G	B				
00H: Off 01H: On 02H: Flashing		00H-FFH	00H-FFH	00H-FFH	00H: Off 01H: On 02H: Flashing		00H-FFH	00H-FFH	00H-FFH				
32 bytes		33 bytes	34 bytes	35 bytes	36 bytes	37 bytes	38 bytes	39 bytes	40 bytes				
4th Tier of LED unit					5th Tier of LED unit				Buzzer				
Status		R	G	B	Status		R	G	B				
00H: Off 01H: On 02H: Flashing		00H-FFH	00H-FFH	00H-FFH	00H: Off 01H: On 02H: Flashing		00H-FFH	00H-FFH	00H-FFH				
										00H: Stop 01H: Buzzer Pattern 1 02H: Buzzer Pattern 2 03H: Buzzer Pattern 3/ buzzer sounds when the buzzer inputs are simultaneously entered (Cont) 0AH: Buzzer pattern 10 0BH: Buzzer pattern 11			

MEMO

- The color information of the LED unit is stored in the RGB color model. Refer to "Correspondance tabelle of RGB color model" on page 112

[Normal Response (45 bytes): When running in Smart Mode]

1 byte	2 bytes	3 bytes	4 bytes	5 bytes	6 bytes	7 bytes	8 bytes	9 bytes	10 bytes	11 bytes	12 bytes	13 bytes	14 bytes
MAC address						Input 1	Input 2	Input 3	Input 4	Input 5	Input 6	Input 7	Input 8
The MAC address of this product is stored.						00H: OFF 01H: ON							

15 bytes	16 bytes	17 bytes	18 bytes	19 bytes	20 bytes	21 bytes	22 bytes
Mode	Open				Smart Mode Status		
					Group No.	Mute	STOP Input
01H (Smart Mode)	00H	00H	00H	00H	01H: Group 1 02H: Group 2 (Cont) 1EH: Group 30 1FH: Group 31	00H: Mute Off 01H: Mute ON	00H: STOP OFF 01H: STOP ON

23 bytes	24 bytes	25 bytes	26 bytes	27 bytes	28 bytes
Smart Mode Status		1st Tier of LED unit			
Pattern No.	Takt Time Overdue	Status	R	G	B
01H: Group 1 02H: Group 2 (Cont) 3EH: Group 62 3FH: Group 63	00H: Not occurred 01H: Occurred	01H: On 02H: Flashing	00H-FFH	00H-FFH	00H-FFH

29 bytes	30 bytes	31 bytes	32 bytes	33 bytes	34 bytes	35 bytes	36 bytes
2nd Tier of LED unit				3rd Tier of LED unit			
Status	R	G	B	Status	R	G	B
01H: On 02H: Flashing	00H-FFH	00H-FFH	00H-FFH	01H: On 02H: Flashing	00H-FFH	00H-FFH	00H-FFH

37 bytes	38 bytes	39 bytes	40 bytes	41 bytes	42 bytes	43 bytes	44 bytes	45 bytes
4th Tier of LED unit				5th Tier of LED unit				Buzzer
Status	R	G	B	Status	R	G	B	Status
01H: On 02H: Flashing	00H-FFH	00H-FFH	00H-FFH	01H: On 02H: Flashing	00H-FFH	00H-FFH	00H-FFH	00H: Stop 01H: Buzzer Pattern 1 02H: Buzzer Pattern 2 03H: Buzzer Pattern 3 (Cont) 0AH: Buzzer pattern 10 0BH: Buzzer pattern 11

Abnormal Response (1 byte)

NAK
15H

■ Command Response Example 1

[MAC address of this machine] 80:39:E5:00:1A:2F

[Mode] Signal Tower Mode

[LED unit] 1st Tier: Red On, 2nd Tier: Yellow On, 3rd Tier: Green Flashing, 4th Tier: Blue On, 5th Tier: White Flashing

[Buzzer] Pattern 1,

[Input] Input 1,3,4,6 are ON

1	2	3	4	5	6	7	8	9	10	11	12	13	14
MAC address						Input 1	Input 2	Input 3	Input 4	Input 5	Input 6	Input 7	Input 8
80H	39H	E5H	00H	1AH	2FH	01H	00H	01H	01H	00H	01H	00H	00H
15	16	17	18	19	20	21	22	23	24	25	26	27	
Mode	Open					1st Tier of LED unit				2nd Tier of LED unit			
						Status	R	G	B	Status	R	G	B
00H	00H	00H	00H	00H	01H	FFH	00H	00H	00H	FFH	CCH	00H	
28	29	30	31	32	33	34	35	36	37	38	39	40	
3rd Tier of LED unit				4th Tier of LED unit				5th Tier of LED unit				Buzzer	
Status	R	G	B	Status	R	G	B	Status	R	G	B	Status	
02H	00H	FFH	00H	01H	00H	33H	FFH	02H	FFH	FFH	FFH	01H	

■ Command Response Example 2

[MAC address of this machine] 80:39:E5:00:1A:2F

[Mode] Smart Mode

[Smart Mode] Group number: 10, Mute input: ON, STOP input: OFF, Pattern Number: 5, Takt Time Overdue: Occurred

[LED unit] 1st Tier : Blue, 2nd Tier: Blue, 3rd Tier: Black (Off), 4th Tier: Purple, 5th Tier: Pink, Flashing

[Buzzer] Mute

[Input] Input 2,4,6,8 are ON

1	2	3	4	5	6	7	8	9	10	11	12	13	14
MAC address						Input 1	Input 2	Input 3	Input 4	Input 5	Input 6	Input 7	Input 8
80H	39H	E5H	00H	1AH	2FH	00H	01H	00H	01H	00H	01H	00H	01H
15	16	17	18	19	20	21	22	23	24				
Mode	Open					Smart Mode Status							
						Group No.		Mute		STOP Input		Pattern No.	
01H	00H	00H	00H	00H	0AH	01H	00H	05H	01H				
25	26	27	28	29	30	31	32	33	34	35	36		
1st Tier of LED unit				2nd Tier of LED unit				3rd Tier of LED unit					
Status	R	G	B	Status	R	G	B	Status	R	G	B		
02H	00H	33H	FFH	02H	00H	33H	FFH	02H	00H	00H	00H		
37	38	39	40	41	42	43	44	45					
4th Tier of LED unit				5th Tier of LED unit				Buzzer					
Status	R	G	B	Status	R	G	B	Status					
02H	CCH	00H	DDH	02H	FFH	00H	CCH	00H					

MEMO

- The LED colors are recorded in RGB color mode. (Refer to "Correspondance table of RGB color model" on page 102)
- In Smart Mode, there is no OFF function for the LED units. If the LED units are OFF in Smart Mode, it will be recorded as Black On or Black Flashing.
- The pattern number is recorded as 0 (00H) in the following conditions:
 - » When running in Smart Mode with the STOP function ON.
 - » When turning the STOP function ON during takt time overdue. (For a group that is set to repeat.)
- When the pattern number is 0, 0 (00H) is recorded for both the LED units and buzzer.

5.1.10. Individual flashing control

Command Description

The color and operation pattern of each tier of the LED unit and the alarm pattern can be specified and controlled in the data field.

Transmission Data Format

Product Category AB		Identifier F	Open	Data Size		Data Area 11 bytes				
41H	42H	46H	00H	00H	0BH	See Below				

Product Category

The product is classified in "AB."

Identifiers

"F" is used.

Data Area

Data Area 11 bytes										
LED Unit					Buzzer	LED Unit				
1	2	3	4	5	6	7	8	9	10	11
Tier 1 Color	Tier 2 Color	Tier 3 Color	Tier 4 Color	Tier 4 Color	Patterns	Tier 1 Flashing Oeration	Tier 2 Flashing Oeration	Tier 3 Flashing Oeration	Tier 4 Flashing Oeration	Tier 5 Flashing Oeration

LED Unit
00H: Off
01H: Red
02H: Amber
03H: Lemon
04H: Green
05H: Sky Blue
06H: Blue
07H: Purple
08H: Pink
09H: White

Buzzer
00H: Stop
01H: Pattern 1
05H: Pattern 5

Flashing Operation
00H: Flashing OFF
01H: Flashing ON

Reply Data

Normal Response (1 byte)

ACK
06H

Abnormal Response (1 byte)

NAK
15H

Command Transmission Example

1st Tier : Yellow On, 2nd Tier: Purple Flashing, 3rd Tier: White Flashing, 4th Tier: Off, 5th Tier: Green On, Flashing: Off, Buzzer: Pattern 5

Product Category AB		Identifier F	Open	Data Size		Data Area										
41H	42H	46H	00H	00H	0BH	02H	07H	09H	00H	04H	05H	00H	01H	01H	00H	00H

5.2. PHN Command

By sending a PHN command from a personal computer, it is possible to turn on and flash the LED unit tiers 1 to 3, and control buzzer patterns 1 and 2. The protocol can be selected from "TCP" or "UDP"

Communication port numbers are "10000-65535."

MEMO

- The PHN Command Setup can be executed with the command reception setting. (Refer to "4.6. RSH Command Configuration.")
- The number of simultaneous connections with a PNS Command and PHN Command is 8 connections.

Write Command

Data can be transmitted in the following formats to control the LED unit tiers 1-3 (from the top) and buzzer (patterns 1 and 2).

"W" (57H) 8 bits								Operation Data 8 bits							
0	1	0	1	0	1	1	1	Refer to Operation Data Contents							

Details of operation data

Operation Data 8 bits								
LED unit Flashing			Buzzer Pattern			LED Unit Lighting		
3rd Tier	2nd Tier	1st Tier	Pattern 2	Pattern 1	3rd Tier	2nd Tier	1st Tier	

Reply Data

Normal Response (1 byte)

A	C	K
41H	43H	4BH

Abnormal Response (1 byte)

N	A	K
4EH	41H	4BH

Command Transmission Example

1st Tier: Lighting, flashing, 2nd Tier: flashing, 3rd Tier: OFF, Buzzer: pattern 2

W (57H)								Operation Data (51H)							
0	1	0	1	0	1	1	1	0	1	0	1	0	0	0	1

CAUTION

- ⚠ The status of the 4th and 5th LED tiers cannot be controlled.
- ⚠ The smart mode cannot be executed.

MEMO

- Priority is given to the lighting input over the flashing input when simultaneous signals are applied.
- Priority is given to buzzer pattern 1 over buzzer pattern 2 when simultaneous signals are applied.

Read Command

Data can be transmitted in the following format to request the current operating status for the LED unit tiers 1-3 (from the top) and buzzer.

"R" (52H) 8 bit							
0	1	0	1	0	0	1	0

Reply Data

R (52H)								Operation Data 8 bit							
								LED unit Flashing			Buzzer Pattern		LED Unit Lighting		
0	1	0	1	0	0	1	0	3 Tiers	2 Tiers	1 Tier	Pattern 2	Pattern 1	3 Tiers	2 Tiers	1 Tier

Data Acquisition Response Example

1st Tier: lighting, 2nd Tier: OFF, 3rd Tier: flashing, Buzzer: pattern 1

R (52H)								Operation Data (89H)							
0	1	0	1	0	0	1	0	1	0	0	0	1	0	0	1

CAUTION

- ⚠ The status of the 4th and 5th LED tiers cannot be acquired.
- ⚠ The smart mode status cannot be acquired.
- ⚠ The Signal line/contact input status cannot be acquired.
- ⚠ Buzzer patterns 3-11 cannot be acquired. The buzzer pattern data contains zeros.

Below are the parameters that can be controlled by each control method.

Command Name	Command Control	Signal Wire Control
Write Command (W)	●	×
Read Command (R)	●	●

5.3. Modbus/TCP

This product can be controlled and obtain its status by transmitting a command from the master that is corresponding to Modbus/TCP protocol.

The communication port numbers are "502, 1024-65535."

MEMO

- The setup of the Modbus/TCP can be done by the Modbus/TCP settings. (Refer to "4.7. Modbus/TCP Setup")
- The number of simultaneous connections in Modbus/TCP is eight.

• Modbus/TCP Data Structure

Transaction Identifier	Protocol Identifier	Field Length	Unit Identifier	Function Code	Data
2 bytes	2 bytes	2 bytes	1 byte	1 byte	n bytes

- Transaction Identifier : 0000-FFFFH
- Protocol Identifier : 0000H Fixed
- Field Length : The number of bytes following the Unit Identifier.
- Unit Identifier : 00-FFH
- Function Code : The code which identifies the function defined in Modbus.
- Data : The data string defined for each function code.

5.3.1. Function Code

The list of function codes supported by this product.

Code (Hex)	Function Name	Functional Description
02H	Read Input Status	The contact input status is read.
03H	Read Holding Registers	The present status of the Signal Tower and buzzer are read.
06H	Write Single Register	1 byte of the data address in the Register is changed, and the Signal Tower and buzzer are controlled.
08H	Diagnostics	Reads the energized state of the Signal Tower control board.
10H	Write Multiple Registers	Two or more bytes of the data address in the Register is changed, and the Signal Tower and buzzer are controlled.

5.3.2. Input Address

The input address list supported by this product.

Input Address	Control Allocation	Condition
1 (01H)	Contact Input 1	0: OFF 1: ON
2 (02H)	Contact Input 2	0: OFF 1: ON
3 (03H)	Contact Input 3	0: OFF 1: ON
4 (04H)	Contact Input 4	0: OFF 1: ON
5 (05H)	Contact Input 5	0: OFF 1: ON
6 (06H)	Contact Input 6	0: OFF 1: ON
7 (07H)	Contact Input 7	0: OFF 1: ON
8 (08H)	Contact Input 8	0: OFF 1: ON

5.3.3. Register Address

The register address list supported by this product.

- Signal Tower Control

Register Address	Control Allocation	Data	Condition
1 (01H)	Signal Tower Control 1st LED Unit Tier	MSN	00H: doesn't control, 01H: controls
		LSN	00H: OFF, 01H : ON, 02H: flashing, 09H: No Change
2 (02H)	Signal Tower Control 2nd LED Unit Tier	MSN	00H: doesn't control, 01H: controls
		LSN	00H: OFF, 01H : ON, 02H: flashing, 09H: No Change
3 (03H)	Signal Tower Control 3rd LED Unit Tier	MSN	00H: doesn't control, 01H: controls
		LSN	00H: OFF, 01H : ON, 02H: flashing, 09H: No Change
4 (04H)	Signal Tower Control 4th LED Unit Tier	MSN	00H: doesn't control, 01H: controls
		LSN	00H: OFF, 01H : ON, 02H: flashing, 09H: No Change
5 (05H)	Signal Tower Control 5th LED Unit Tier	MSN	00H: doesn't control, 01H: controls
		LSN	00H: OFF, 01H : ON, 02H: flashing, 09H: No Change
6 (06H)	Signal Tower Control Buzzer	MSN	00H: doesn't control, 01H: controls
		LSN	00H: STOP, 01H-03H: buzzer patterns 1-3 (Writing) 0H: STOP, 01H-0BH: buzzer patterns 1-11 (Reading)

- Smart Mode

Register Address	Control Allocation	Data	Condition
7 (07H)	Smart Mode Control	MSN	00H: doesn't control, 01H: controls
		LSN	01H-1FH: Group Numbers 1-31
8 (08H)	Clear	MSN	00H (Fixed settings)
		LSN	00H: No Change / Reading, 01H: Execute Clear
9 (09H)	Mute	MSN	00H (Fixed settings)
		LSN	00H: Mute cancel, 01H: Mute execution
10 (0AH)	STOP	MSN	00H (Fixed settings)
		LSN	00H: STOP cancel, 01H: STOP execution
11 (0BH)	Pulse Trigger Input	MSN	00H (Fixed settings)
		LSN	00H: No Change / Reading, 01H: pattern change

• Detailed Command Control

Register Address	Control Allocation	Data	Condition
12 (0CH)	Detailed Command Control 1st LED Unit Tier	MSN	00H: doesn't control, 01H: Controls
		LSN	00H: OFF, 01H-09H: Display Color *
13 (0DH)	Detailed Command Control 2nd LED Unit Tier	MSN	00H: doesn't control, 01H: Controls
		LSN	00H: OFF, 01H-09H: Display Color *
14 (0EH)	Detailed Command Control 3rd LED Unit Tier	MSN	00H: doesn't control, 01H: Controls
		LSN	00H: OFF, 01H-09H: Display Color *
15 (0FH)	Detailed Command Control 4th LED Unit Tier	MSN	00H: doesn't control, 01H: Controls
		LSN	00H: OFF, 01H-09H: Display Color *
16 (10H)	Detailed Command Control 5th LED Unit Tier	MSN	00H: doesn't control, 01H: Controls
		LSN	00H: OFF, 01H-09H: Display Color *
17 (11H)	Detailed Command Control Flashing COM	MSN	00H: doesn't control, 01H: Controls
		LSN	00H: All tiers Flashing OFF , 01H: All tiers Flashing ON
18 (12H)	Detailed Command Control Buzzer	MSN	00H: doesn't control, 01H: Controls
		LSN	00H: Stop, 01H-0BH: Buzzer Pattern 1-11
19 (13H)	Detailed Command Control Individual flashing of Tier 1	MSN	00H: doesn't control, 01H: Controls
		LSN	00H: Flashing OFF , 01H: Flashing ON
20 (14H)	Detailed Command Control Individual flashing of Tier 2	MSN	00H: doesn't control, 01H: Controls
		LSN	00H: Flashing OFF , 01H: Flashing ON
21 (15H)	Detailed Command Control Individual flashing of Tier 3	MSN	00H: doesn't control, 01H: Controls
		LSN	00H: Flashing OFF , 01H: Flashing ON
22 (16H)	Detailed Command Control Individual flashing of Tier 4	MSN	00H: doesn't control, 01H: Controls
		LSN	00H: Flashing OFF , 01H: Flashing ON
23 (17H)	Detailed Command Control Individual flashing of Tier 5	MSN	00H: doesn't control, 01H: Controls
		LSN	00H: Flashing OFF , 01H: Flashing ON

* Specific data for Display Color.

Display Color	Data	Display Color	Data	Display Color	Data
Red	01H	Green	04H	Purple	07H
Amber	02H	Sky-blue	05H	Pink	08H
Lemon Yellow	03H	Blue	06H	White	09H

MEMO

- When each mode is controlled at the same time, priority is given as indicated below:
Clear → Signal Tower Control → Smart Mode → Detailed Command Control
- When operating in a particular mode, but if you immediately change to another mode to operate of the functions (Lighting, Flashing, Mute, etc), the register data status does not transfer.
- When controlling via signal wire control, if the Signal Tower input judgement is set to Normal, the LED unit flashing cannot be acquired. The status (Light ON or OFF) can be acquired at that time.
- 31 groups can be designated when it is operating a single-display type for the Smart Mode.
- 15 groups can be designated when it is operating with the Time-trigger type or pulse-trigger type. (01H-0FH)
- To execute Mute, STOP, and Pulse-Trigger Input simultaneously, be sure to specify 9-11 with one command.
- When all the MSN of the read data is set to 00H.
- Clear can be operated in any mode.
- When reading Registry Addresses from one mode to another, the incompatibility will cause the registry data to do different things, such as, having the detailed command control mode have Green LED (04H) light on all tiers be read into the Signal Tower mode, will change the condition to check if an LED Unit is on (01H).
- Buzzer pattern 1 or Buzzer pattern 5 can be controlled during individual flashing control.
- When controlling individual flashing, set Flashing COM to "doesn't control".

5.3.4. Register Allocation Example

Coil/Register Numbers	Input Address	Control Allocation	Example Data Integer
10001	1 (01H)	Contact Input 1	Input 1 on: 1
10002	2 (02H)	Contact Input 2	Input 2 on: 1
10003	3 (03H)	Contact Input 3	Input 3 on: 1
10004	4 (04H)	Contact Input 4	Input 4 on: 1
10005	5 (05H)	Contact Input 5	Input 5 on: 1
10006	6 (06H)	Contact Input 6	Input 6 on: 1
10007	7 (07H)	Contact Input 7	Input 7 on: 1
10008	8 (08H)	Contact Input 8	Input 8 on: 1

Register Address	Register Numbers	Example Data Integer
1 (01H)	40001	Lighting On: 0101H = 257 Flashing: 0102H = 258
2 (02H)	40002	Lighting On: 0101H = 257 Flashing: 0102H = 258
3 (03H)	40003	Lighting On: 0101H = 257 Flashing: 0102H = 258
4 (04H)	40004	Lighting On: 0101H = 257 Flashing: 0102H = 258
5 (05H)	40005	Lighting On: 0101H = 257 Flashing: 0102H = 258
6 (06H)	40006	Buzzer Pattern 1 On: 0101H = 257 Buzzer Pattern 2 On: 0102H = 258
7 (07H)	40007	Smart Mode 1: 0101H = 257 Smart Mode 15: 010FH = 271
8 (08H)	40008	Execute Clear: 0001H = 1
9 (09H)	40009	Cancel Mute: 0000H = 0 Execute Mute: 0001H = 1
10 (0AH)	40010	Cancel STOP: 0000H = 0 Execute STOP: 0001H = 1
11 (0BH)	40011	Pattern Change: 0001H = 1
12 (0CH)	40012	Lighting On (Red): 0101H = 257 Lighting On (Amber): 0102H = 258
13 (0DH)	40013	Lighting On (Lemon Yellow): 0103H = 259 Lighting On (Green): 0104H = 260
14 (0EH)	40014	Lighting On (Sky-blue): 0105H = 261 Lighting On (Blue): 0106H = 262
15 (0FH)	40015	Lighting On (Purple): 0107H = 263 Lighting On (Pink): 0108H = 264
16 (10H)	40016	Lighting On (White): 0109H = 265 Lighting Off: 0100H = 256
17 (11H)	40017	Flashing OFF: 0100H = 256 Flashing ON: 0101H = 257
18 (12H)	40018	Buzzer Pattern 1: 0101H = 257 Buzzer Pattern 11: 010BH = 267
19 (13H)	40019	Flashing OFF: 0100H = 256 Flashing ON: 0101H = 257
20 (14H)	40020	Flashing OFF: 0100H = 256 Flashing ON: 0101H = 257
21 (15H)	40021	Flashing OFF: 0100H = 256 Flashing ON: 0101H = 257
22 (16H)	40022	Flashing OFF: 0100H = 256 Flashing ON: 0101H = 257
23 (17H)	40023	Flashing OFF: 0100H = 256 Flashing ON: 0101H = 257

5.3.5. Command Transmission Example

<Read Input Status (02H)>

Control Command

Transaction Identifier	Protocol Identifier	Field Length	Unit Identifier	Function Code	Data	
					Start Address	Number of inputs
00H 00H	00H 00H	00H 06H	01H	02H	00H 00H	00H 08H

Specify -1 as the first input address to obtain the status for the start address.
For the number of inputs, specify the number of inputs to get a status from.

Reply Command

In this example, contact input 2 is set to ON and all other contact inputs are OFF.

Transaction Identifier	Protocol Identifier	Field Length	Unit Identifier	Function Code	Data	
					byte Count	Input 1-8
00H 00H	00H 00H	00H 04H	01H	02H	01H	02H

Input (8 Bits)	8	7	6	5	4	3	2	1
Status (02H)	0	0	0	0	0	0	1	0

<Read Holding Registers (03H)>

Control Command

Transaction Identifier	Protocol Identifier	Field Length	Unit Identifier	Function Code	Data	
					Start Address	Number of inputs
00H 01H	00H 00H	00H 06H	01H	03H	00H 00H	00H 06H

Specify -1 as the first register address to obtain the status for the start address.
For the number of registers, specify the number of registers to obtain the status from.

Reply Command

When the Signal Tower is in the Signal Tower mode, the 1st tier is lighting, the 2nd tier flashing, the 3rd to 5th tier is OFF, and buzzer pattern 1 is ON.

Transaction Identifier	Protocol Identifier	Field Length	Unit Identifier	Function Code
00H 01H	00H 00H	00H 0FH	01H	03H

Data						
byte Count	Register 1	Register 2	Register 3	Register 4	Register 5	Register 6
0CH	00H 01H	00H 02H	00H 00H	00H 00H	00H 00H	00H 01H

<Write Single Register (06H)>

Control Command

The Signal Tower is switched to group number 15 of the smart mode.

Transaction Identifier	Protocol Identifier	Field Length	Unit Identifier	Function Code	Data	
					Address	Register 7
00H 02H	00H 00H	00H 06H	FFH	06H	00H 06H	01H 0FH

For the address, specify -1 of the register address to control.
In the register, specify the desired status to control.

Reply Command

Transaction Identifier	Protocol Identifier	Field Length	Unit Identifier	Function Code	Data	
					Address	Register 7
00H 02H	00H 00H	00H 06H	FFH	06H	00H 06H	01H 0FH

<Diagnostics (08H)>

Control Command

Transaction Identifier	Protocol Identifier	Field Length	Unit Identifier	Function Code	Data	
					Diagnostic Sub-code	Data
00H 03H	00H 00H	00H 06H	00H	08H	00H 00H	00H 00H

Diagnostic Sub-code : 00H 00H Fixed

Data : 00H 00H Fixed

Reply Command

When the LA6-POE control board inside the Signal Tower can be turned on.

Transaction Identifier	Protocol Identifier	Field Length	Unit Identifier	Function Code	Data	
					Diagnostic Sub-code	Data
00H 03H	00H 00H	00H 06H	00H	08H	00H 00H	00H 01H

Response data when PCB is broken. : 00H 00H

Response data when PCB is working normally. : 00H 01H

<Write Multiple Registers (10H)>

Control Command ①

When the 1st Signal Tower tier is on, the 2nd tier is flashing, the 3rd tier has no change, the 4th and 5th tiers are OFF, and buzzer pattern 2 is ON.

Transaction Identifier	Protocol Identifier	Field Length	Unit Identifier	Function Code
00H 04H	00H 00H	00H13H	00H	10H

Data								
Start Address	Register No.	byte Count	Register 1	Register 2	Register 3	Register 4	Register 5	Register 6
00H 00H	00H 06H	0CH	01H 01H	01H 02H	00H 00H	01H 00H	01H 00H	01H 02H

For the start address, specify -1 of the first register address to control.

For the number of registers, specify the number of registers to transmit.

For the number of bytes, specify the number of bytes of the register to be transmitted.

Reply Command

Transaction Identifier	Protocol Identifier	Field Length	Unit Identifier	Function Code	Data	
					Start Address	Register No.
00H 04H	00H 00H	00H 06H	00H	10H	00H 00H	00H 06H

Control Command ②

When the 1st tier (Red), 2nd tier (Red), 3rd tier (Sky-blue), 4th tier (Purple), 5th tier (White) of the Signal Tower are all flashing and buzzer pattern 11 is ON.

Transaction Identifier	Protocol Identifier	Field Length	Unit Identifier	Function Code
00H 00H	00H 00H	00H15H	00H	10H

Data							
Start Address	Register No.	byte Count	Register 12	Register 13	Register 14	Register 15	Register 16
00H 0BH	00H 07H	0EH	01H 01H	01H 01H	01H 05H	01H 07H	01H 09H

Data	
Register 17	Register 18
01H 01H	01H 0BH

For the start address, specify -1 of the first register address to control.

For the number of registers, specify the number of registers to transmit.

For the number of bytes, specify the number of bytes of the register to be transmitted.

Reply Command

Transaction Identifier	Protocol Identifier	Field Length	Unit Identifier	Function Code	Data	
					Start Address	Register No.
00H 00H	00H 00H	00H 06H	00H	10H	00H 0BH	00H 07H

Control Command ③

Signal tower settings: Tier 1 White continuous on, Tier 2 flashing Red, Tier 3 Off, Tier 4 flashing Sky-blue, Tier 5 Peach continuous on, Buzzer sounding Pattern 1

Transaction Identifier	Protocol Identifier	Field Length	Unit Identifier	Function Code
00H 00H	00H 00H	00H15H	00H	10H

Data							
Start Address	Register No.	byte Count	Register 12	Register 13	Register 14	Register 15	Register 16
00H 0BH	00H 12H	14H	01H 09H	01H 01H	01H 00H	01H 05H	01H 08H

Data						
Register 17	Register 18	Register 19	Register 20	Register 21	Register 22	Register 23
00H 00H	01H 01H	01H 00H	01H 01H	01H 00H	01H 01H	01H 00H

For the start address, specify -1 of the first register address to control.

For the number of registers, specify the number of registers to transmit.

For the number of bytes, specify the number of bytes of the register to be transmitted.

Reply Command

Transaction Identifier	Protocol Identifier	Field Length	Unit Identifier	Function Code	Data	
					Start Address	Register No.
00H 00H	00H 00H	00H 15H	00H	10H	00H 0BH	00H 12H

<Exception Response>

The list of exceptions which this product answers responses to.

Hex Code	Function Name	Functional Description
01H	illegal Function	It responds to an unmatched function code which is received.
02H	illegal Data Address	It responds when an unassigned data address is specified.
03H	illegal Data Value	It responds when unassigned data values are specified.

The exception response is set to where 1 is the most significant bit of the received function code (80H is added) when it responds.

Unsupported function code command

Transaction Identifier	Protocol Identifier	Field Length	Unit Identifier	Function Code	Data	
					Start Address	Number of inputs
00H 00H	00H 00H	00H 06H	01H	09H	00H 00H	00H 08H

Exception Response

Transaction Identifier	Protocol Identifier	Field Length	Unit Identifier	Function Code	Exception Code
00H 00H	00H 00H	00H 03H	01H	89H	01H

Below are the parameters that can be controlled by each control method.

Function code name	Command Control	Signal Wire Control
Read Input Status	●	●
Read Holding Registers	●	●
Write Single Register	●	×
Diagnostics	●	●
Write Multiple Registers	●	×

5.4. Mirroring

Up to **nine** LA6-POE Signal Towers can be in the same status by sending the status of the LA6-POE which is being controlled by the Master via the signal line, to another **one of eight** LA6-POE Signal Towers connected within the network.

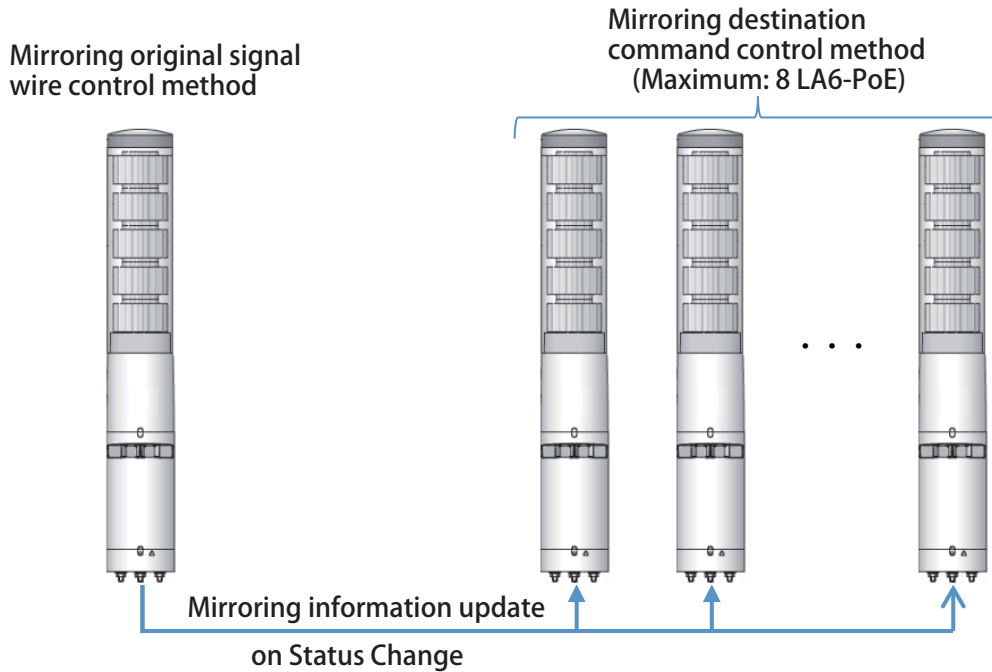

When setting the LA6-POE control by a signal line, (Refer to "4.9.1 Setting up the Mirroring Source" on page 33)

When setting the LA6-POE control by command, (Refer to "4.9.2 Setup Mirroring Destination Point" on page 34)

MEMO

- The maximum possible number of mirrored LA6-POE Signal Towers is eight units.
- Even if the mirroring source status does not change, the mirroring information is updated every 10 seconds.
- Even if a clear is executed at the mirroring destination, if 10 seconds elapse, or the signal line status changes, the mirroring source status will be reflected.

5.5. Signal Wire Control

This product has two methods of control, by a signal line input or controlling by commands. This item describes the control method by a signal line.

There are two kind of signal line control modes, "Signal Tower Mode" and "Smart Mode". Switching between the "Signal Tower Mode" and "Smart Mode" is done by the ON/OFF of the "Mode Change".

- Mode Change Switch ON: Smart mode
- Mode Change Switch OFF: Signal Tower mode

Although a fundamental level hold controls the inputs, only a trigger input in the Pulse-trigger type for the smart mode turns into a one shot input.

5.5.1. Signal Tower Mode

The Signal Tower Mode controls operation with ON/OFF inputs from the wires currently assigned to each LED and buzzer, like our conventional Signal Towers. When short-circuiting each input to the "Flashing/Pulse Enable Common", The LED will flash, and an intermittent buzzer sound will occur.

For the LED unit setup, (Refer to "4.4 LED Unit Setup" on page 24)

<Operation Example>

For inputs 1-7, an example of an output of the operation is shown.

Operating Status	LED Tier 1	Off	Red ON	Off	Off	Red ON	Off
	LED Tier 2	Off	Off	Amber On	Off	Off	Off
	LED Tier 3	Off	Off	Green ON	Green ON	Green ON	Off
	LED Tier 4	Off	Off	Blue On	Blue On	Off	Off
	LED Tier 5	Off	Off	Off	White ON	Off	Off
	Buzzer	Mute	Sound No.1	Sound No.2	Mute	Sound No.3	Sound No.2

Signal Input	Input 1	
	Input 2	
	Input 3	
	Input 4	
	Input 5	
	Input 6	
	Input 7	

* Factory settings

5.5.2. Smart Mode

There are three kind of modes, "Time-trigger Type", "Pulse-Trigger Type", and "Single-display Type". The main mode has common functions for each type and has the following at this mode.

<Input5(STOP/Pulse Input)>

When the input is set to ON, the following occurs to each smart mode.

- Time-trigger Type
 - Halts the progress of pattern changes.
(If you programmed a custom pattern, that pattern will be displayed.)
- Pulse-Trigger Type
 - Activates the pulse trigger.
- Single-Display Type
 - Input 5 is used for pattern selection.

<Input 6 (Mute Input)>

The buzzer sound stops when an "ON" input occurs, and muffles the sound.

<Input 7 (Clear Input)>

If an input for each type is set to ON, the pattern contents which are controlling the operation will be initialized and it will return to the first pattern. Also, LED's from all the tiers will go out at an "ON" input, and the buzzer is also muffled. For the LED unit setup, (Refer to "4.4 LED Unit Setup" on page 24)

MEMO

The "Flashing/Pulse Enable Common" cannot be used in the smart mode.

5.5.2.1. Time-trigger Type

The pattern transitions can be controlled in accordance to time. Execute up to a maximum of 15 groups, with inputs 1-4.

<Input-group compatibility table>

For inputs 1-4, group No. in the combination of ON/OFF can be put into the diagram.

Group No.	Input 1	Input 2	Input 3	Input 4
1	ON			
2		ON		
3	ON	ON		
4			ON	
5	ON		ON	
6		ON	ON	
7	ON	ON	ON	
8				ON
9	ON			ON
10		ON		ON
11	ON	ON		ON
12			ON	ON
13	ON		ON	ON
14		ON	ON	ON
15	ON	ON	ON	ON

An empty cell indicates the "OFF" condition.

* The following control can be done with the Time-trigger type.

- Turn on input 5 → Use STOP to halt the progress of pattern changes.
- Turn on input 6 → Mute the buzzer.
- Turn on input 7 → The operation and time progress is controlled with a "Clear" (reset)

<Operation Example>

The following are examples of the Time-trigger type operation. In addition to time progress and pattern changes, the figure also shows the mute input operation.

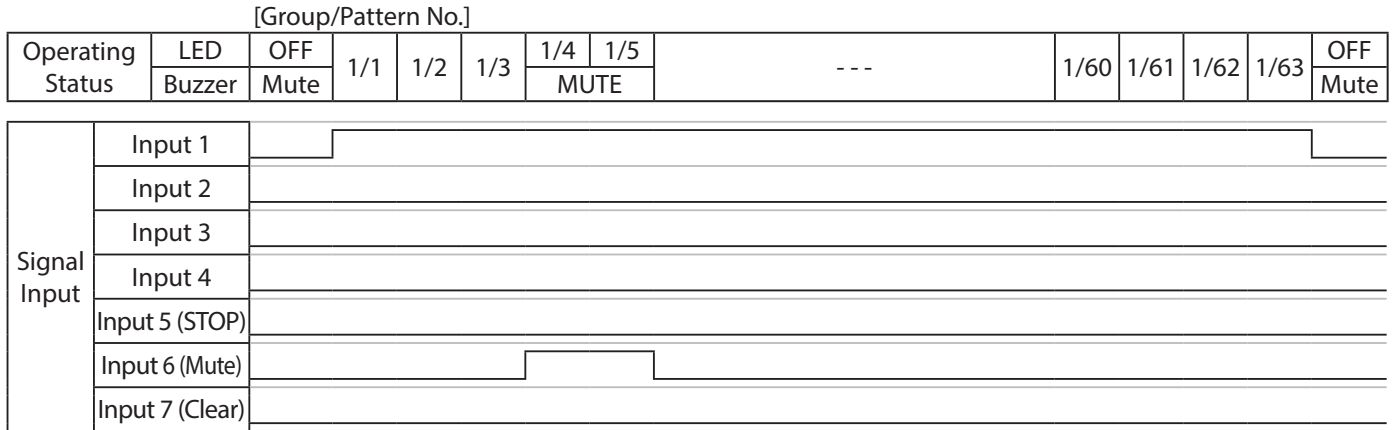

* The Time-trigger type operating state is an example for setting data.

In addition to time progress and pattern changes, the figure also shows the STOP input operation, the mute input, and the clear input. A STOP input setup shows an indication of the pattern at a STOP input by flashing.

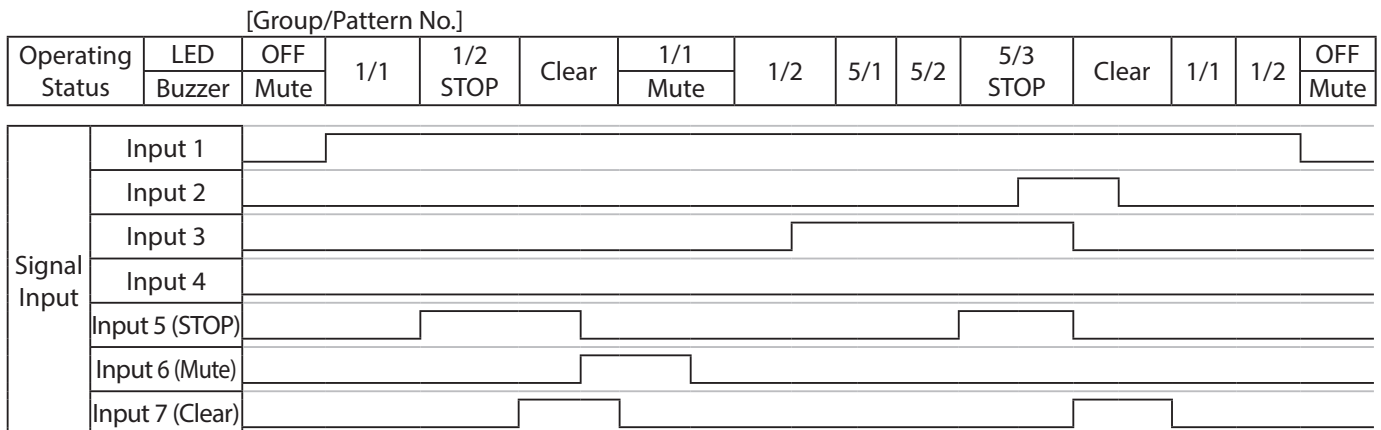

* The Time-trigger type operating state is an example for setting data.

5.5.2.2. Pulse-trigger Type

Pattern transition is changed by a pulse trigger (one shot pulse) input.

A pulse trigger is entered using input 5. Execute up to a maximum of 15 groups, with inputs 1-4.

<Input-group compatibility table>

For inputs 1-4, group No. in the combination of ON/OFF can be put into the diagram.

Group No.	Input 1	Input 2	Input 3	Input 4
1	ON			
2		ON		
3	ON	ON		
4			ON	
5	ON		ON	
6		ON	ON	
7	ON	ON	ON	
8				ON
9	ON			ON
10		ON		ON
11	ON	ON		ON
12			ON	ON
13	ON		ON	ON
14		ON	ON	ON
15	ON	ON	ON	ON

An empty cell indicates the "OFF" condition.

* The following control can be done with the Pulse-trigger type.

- Turn on input 5 (one shot pulse) → Pattern changes.
- Turn on input 6 → Mute the buzzer.
- Turn on input 7 → The operation and pulse number is controlled with a "Clear" (reset)

<Operation Example>

The following are examples of the Pulse-trigger type operation. In addition to trigger input and pattern changes, the figure below shows the operation of the mute input.

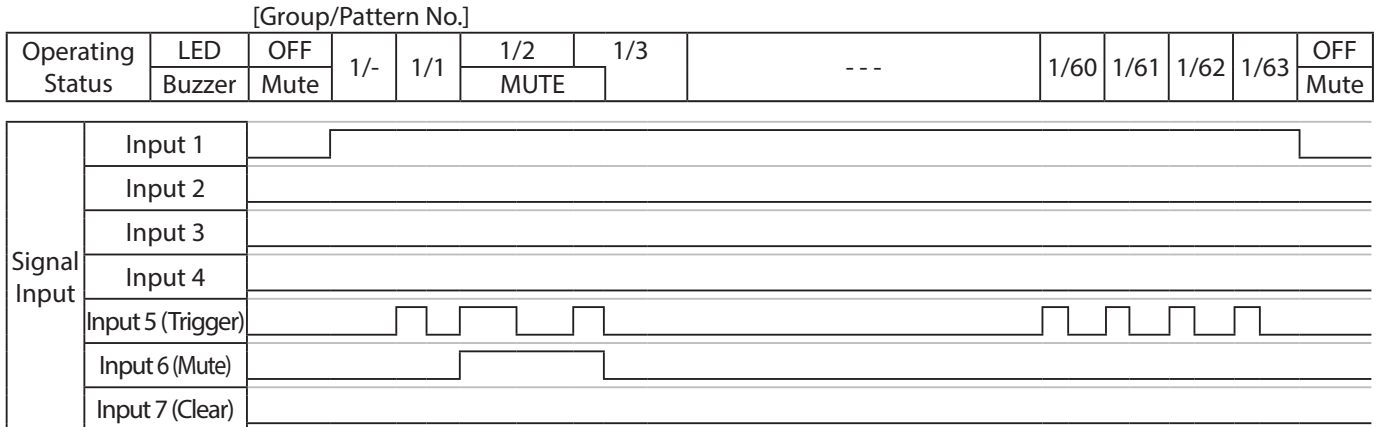

* The Pulse-trigger type operating state is an example for setting data.

In addition to trigger input and pattern changes, the figure below shows the operation of the mute input and the clear input.

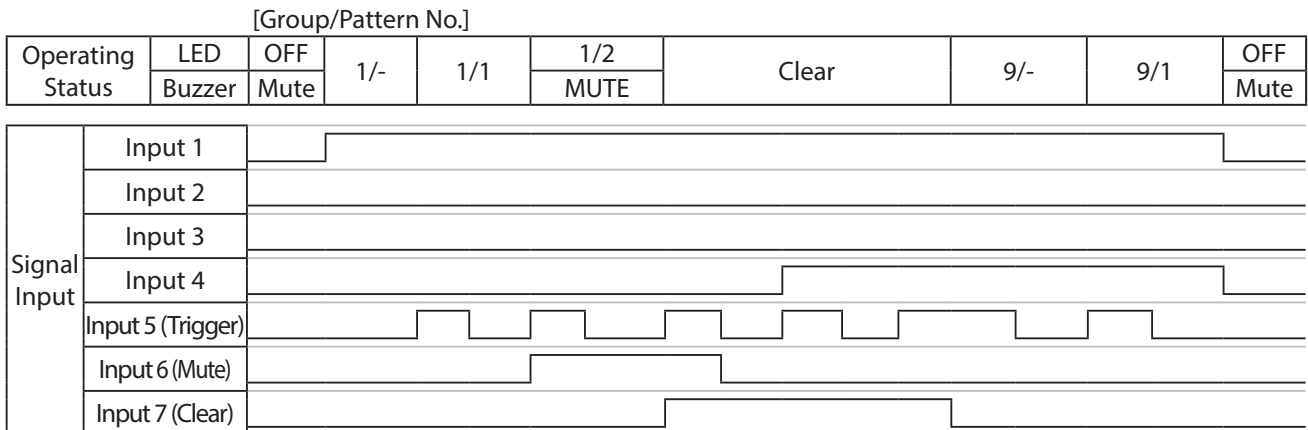

MEMO The one shot trigger input pulse acquires only the rise-time of the input.

5.5.2.3. Single-display Type

Execute 31 registered pattern selections with inputs 1 to 5.

<Input- Group Compatibility Table>

For inputs 1-5, Pattern numbers in combination of ON/OFF can be put into the diagram.

Pattern No.	Input 1	Input 2	Input 3	Input 4	Input 5
1	ON				
2		ON			
3	ON	ON			
4			ON		
5	ON		ON		
6		ON	ON		
7	ON	ON	ON		
8				ON	
9	ON			ON	
10		ON		ON	
11	ON	ON		ON	
12			ON	ON	
13	ON		ON	ON	
14		ON	ON	ON	
15	ON	ON	ON	ON	
16					ON

Pattern No.	Input 1	Input 2	Input 3	Input 4	Input 5
17	ON				ON
18		ON			ON
19	ON	ON			ON
20			ON		ON
21	ON		ON		ON
22		ON	ON		ON
23	ON	ON	ON		ON
24				ON	ON
25	ON			ON	ON
26		ON		ON	ON
27	ON	ON		ON	ON
28			ON	ON	ON
29	ON		ON	ON	ON
30		ON	ON	ON	ON
31	ON	ON	ON	ON	ON

An empty cell indicates the "OFF" condition.

* The following control can be done with the Single-display type.

- Turn on input 6 → Mute the buzzer.
- Turn on input 7 → Operation "Clear" (reset)

<Operation Example>

The following are examples of the Single-display type operation.

[Group/Pattern No.]

Operating Status	LED	OFF	Pattern 1	OFF	Pattern 2	Pattern 10	Pattern 21	Clear	Pattern 1	OFF	
	Buzzer	Mute		Mute		Mute	Mute				
Signal Input	Input 1	[Timing diagram showing pulse]									
	Input 2	[Timing diagram showing pulse]									
	Input 3	[Timing diagram showing pulse]									
	Input 4	[Timing diagram showing pulse]									
	Input 5	[Timing diagram showing pulse]									
	Input 6 (Mute)	[Timing diagram showing pulse]									
	Input 7 (Clear)	[Timing diagram showing pulse]									

5.5.3. Input Signal Time Chart

If an input signal status is maintained by the data lead time indicated for this product, the input status is decided inside the product.

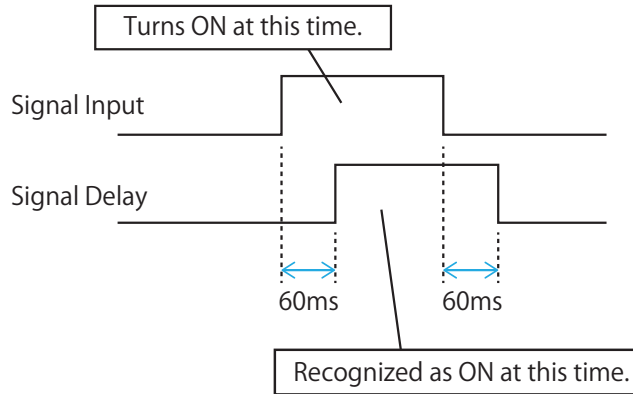

5.5.4. Trigger Input Signal Time Chart

Unlike other inputs, the trigger input in the "Smart Mode" turns into a one shot input. As the time in detection rises, and is maintained, the next detection is not recognized.

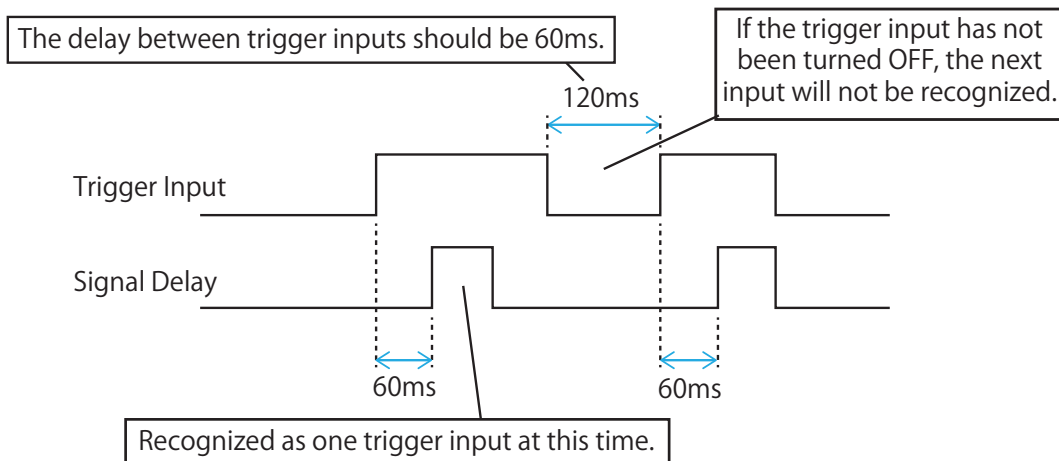

5.6. "Clear" Function

This product can be cleared by using the "Clear" function. The clear function only operates while using the command control method.

- The Clear status indicates the following status:
 - To turn an LED Unit OFF
 - To STOP the Buzzer sound
 - To turn the Mute input OFF
 - To turn the STOP input OFF

The method of executing the clear function is as follows:

- Push the "Clear" switch (**SN**)

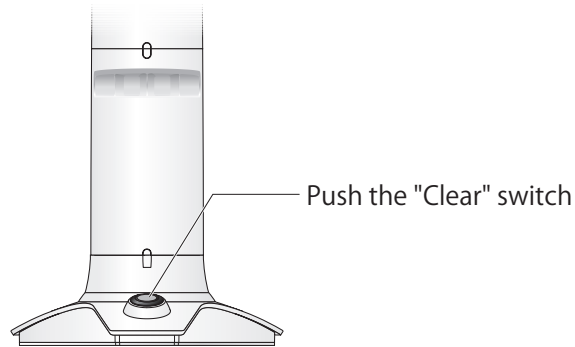

- Perform "Clear" with the contact input detection function (Refer to "5.7 Contact Input Detection" on page 70).

CAUTION

⚠ While using the signal line control method, the "Clear" operation will not operate, even if the "Clear" switch is pushed.

5.7. Contact Input Detection

Use the contact inputs 1-4 to perform the operation set up by operating the contacts. The operation can be selected from "No action", "Clear", "mute", "STOP", and "Trigger". (Refer to "4.8 Contact Input Detection" on page 31)

Select Operation	Operation Contents
No action	<ul style="list-style-type: none"> It doesn't operate.
Clear	<ul style="list-style-type: none"> By turning on the contact set up to clear, the "Clear" operation will be executed. (Refer to "5.6 "Clear" Function" on page 69)
Mute	<ul style="list-style-type: none"> By turning on the contact set up for mute, the Mute input is turned on. While the mute input is set to ON, the buzzer will not sound. When the contact is turned off, the Mute input will also turn off.
STOP	<ul style="list-style-type: none"> By turning on the contact set up for STOP, the STOP input will turn ON. While the STOP input is ON, the operation for the STOP input is executed. When the contact is turned OFF, the STOP input will also turn off.
Trigger Input	<ul style="list-style-type: none"> By turning on the contact set up for the pulse trigger input, the operation for the pulse trigger is turned on. Whenever the contact is turned on, the pattern changes.

MEMO

- The contact input detection function can be performed only while using the command control method.
- The Mute input is effective only while the Smart mode is running.
- The STOP input is effective only when the Time-trigger type in Smart mode is running.
- The trigger input is effective only during Pulse-trigger mode when Smart mode is running.

<Operation Example>

Execute in smart mode (Time-trigger Type) with identifier "T" in a PNS Command.

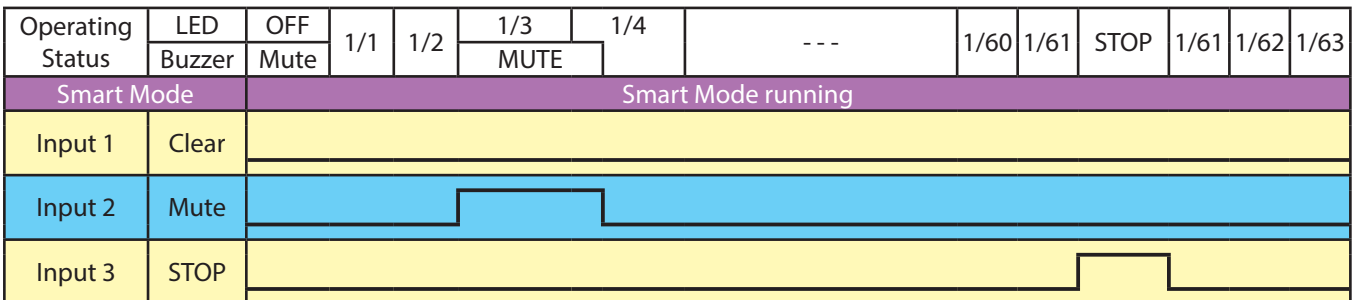

Execute in smart mode (Time-trigger Type) with identifier "T" in a PNS Command.

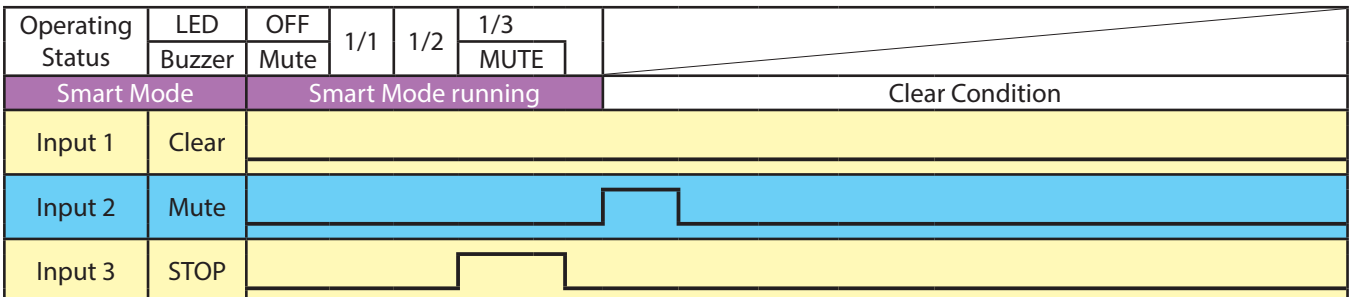

Execute in smart mode (Pulse-trigger type) with identifier "T" in a PNS command.

Operating Status	LED	OFF	1/-	1/1	1/2	1/3	1/4	1/5	1/6
	Buzzer	Mute			MUTE				
Smart Mode		Smart Mode running							
Input 1	Clear	[High]							
Input 2	Mute	[Pulse]							
Input 3	STOP	[Pulse]							

Execute in smart mode (Pulse-trigger type) with identifier "T" in a PNS command.

Operating Status	LED	OFF	1/-	1/1	1/2	1/3				
	Buzzer	Mute			MUTE		Clear Condition			
Smart Mode		Smart Mode running					Clear Condition			
Input 1	Clear	[High]					[Pulse]			
Input 2	Mute	[Pulse]					[High]			
Input 3	Trigger	[Pulse]								

5.8. HTTP Command

The visual and audible signals of this product can be controlled by using an HTTP command.

- HTTP Command Control

Below are the parameters that can be controlled by each control method.

Parameters	Command Control	Signal Wire Control
alert	●	×
smart	●	×
pulse	●	×
mute	●	×
stop	●	×
color	●	×
buzzer	●	×
flash	●	×
flashe	●	×
clear	●	×
user	●	×
pass	●	×

- HTTP Detailed Status Acquisition Command

Below are the parameters that can be controlled by each control method.

Parameters	Command Control	Signal Wire Control
format	●	●
user	●	●
pass	●	●

5.8.1. HTTP Command Control

This product can be controlled by transmitting a HTTP command from the HTTP client.

[Specification of HTTP command control]

Protocol	HTTP	
Method	GET	
Syntax	http://<IP address>/api/control?<parameter name>=<value>[&<parameter name>=<value>]	
Response	Success.	The parameter value is valid
	Error.	The parameter value is invalid

Parameter	Values	Description
alert=< integer value >	6 digits	Each LED tier as well as the buzzer can be controlled. Specify the pattern in order of [Tier 1, Tier 2, Tier 3, Tier 4, Tier 5, Buzzer]. [Tier 1 -5] 0 : Off, 1 : On, 2 : Flashing, 9 : No Change [Buzzer] 0 : Stop, 1 : Pattern 1, 2 : Pattern 2, 3 : Buzzer sound when multiple buzzers are ON simultaneously, 9 : No Change
smart=< integer value >	1 - 31	Activates Smart Mode. Select a group number to run.
pulse=< integer value >	1	Activates the pulse trigger.
mute=< integer value >	0, 1	Turn buzzer ON / OFF while in Smart Mode.
stop=< integer value >	0, 1	Turn the STOP function ON / OFF while in Time-trigger Mode.
color=< integer value >	5 digits	Set the color of each LED tier. 0 : Off, 1 : Red, 2 : Amber, 3 : Lemon, 4 : Green, 5 : Sky Blue, 6 : Blue, 7 : Purple, 8 : Pink, 9 : White
buzzer=< integer value >	0 - 11	Set the Buzzer Pattern. 0 : Stop, 1 - 11 : Buzzer patterns 1 - 11.
flash=< integer value >	1	The LED unit will flash.
flashe=< integer value >	5 digits	Flashes LED unit for each tier. 0 : On, 1 : Flashing
clear=< integer value >	1	Turns OFF LED units and buzzer.
user=< string >	Max. 16 characters	Specify the username for User authentication.
pass=< string >	Max. 16 characters	Specify the password for User authentication.

MEMO

- Always specify both the COLOR and BUZZER values at the same time.
- Below are a list of parameter values that can be specified simultaneously:
 - » smart&pulse
 - » color&buzzer
 - » color&buzzer&flash
 - » color&buzzer&flashe
- Cannot specify "flash" and "flashe" at the same time.
- When "flashe" is specified, "buzzer" can be set to 1 (buzzer Pattern 1) or 5 (buzzer Pattern 5).
- Be sure to specify "user" and "pass" at the same time.

(LAN unit firmware Ver 1.07 or higher)

Example**<alert>**

Tier 1: Continuous light, Tier 2 / Tier 3: Flashing, Tier 4: Lights-OFF, Tier 5: No change, Buzzer: Pattern 1

<http://192.168.10.1/api/control?alert=122091>**<smart>**

When using Smart Mode Group 10

<http://192.168.10.1/api/control?smart=10>**<pulse>**

In Pulse-trigger mode, when there is a trigger input and the pattern is changed.

<http://192.168.10.1/api/control?pulse=1>**<smart and pulse>**

When using Smart Mode Group 1 (pulse trigger input)

<http://192.168.10.1/api/control?smart=1&pulse=1>**<mute>**

Turn mute ON while in Smart Mode

<http://192.168.10.1/api/control?mute=1>

Turn mute OFF

<http://192.168.10.1/api/control?mute=0>**<stop>**

Turn Stop function ON while in Time-trigger Mode

<http://192.168.10.1/api/control?stop=1>

Turn Stop function OFF

<http://192.168.10.1/api/control?stop=0>**<color and buzzer>**

Tier 1: Green, Tier 2: Blue, Tier 3: OFF, Tier 4: White, Tier 5: Red, and Buzzer Pattern 11

<http://192.168.10.1/api/control?color=46091&buzzer=11>**<color and buzzer and flash>**

Tier 1: Green, Tier 2: Blue, Tier 3: OFF, Tier 4: White, Tier 5: Red, Buzzer Pattern 11, and Flashing ON

<http://192.168.10.1/api/control?color=46091&buzzer=11&flash=1>**<color and buzzer and flashe>**

Control settings: Tier 1 green continuous on, Tier 2 flashing blue, Tier 3 off, Tier 4 flashing white, Tier 5 red continuous on, alarm sounding Pattern 5

<http://192.168.10.1/api/control?color=46091&buzzer=5&flashe=01010>**<clear>**

When turning OFF the LED units and buzzer

<http://192.168.10.1/api/control?clear=1>**<color and buzzer and flashe>**

Controlling with user name: patlite, password: patlite: Tier 1: continuous on, Tiers 2 and 3: flashing, Tier 4: off, Tier 5: no change, Alarm: Pattern 1.

<http://192.168.10.1/api/control?alert=122091&user=patlite&pass=patlite>

5.8.2. HTTP Detailed Status Acquisition Command

The command statuses and firmware version of this product can be acquired by using an HTTP command.

Protocol	HTTP	
Method	GET	
Syntax	http://<IPAddress>/api/status?<parameter name>=<value>[&<parameter name>=<value>]	
Response data	Response data (TEXT / JSON format).	The parameter value is valid.
	Error.	The parameter value is invalid.

Parameter	Values	Description
format=<string>	text, json	Acquire the signal tower status data via specified format. text : Text format data, json : JSON format data
user=< string >	Max. 16 characters	Specify the username for User authentication.
pass=< string >	Max. 16 characters	Specify the password for User authentication.

MEMO

When making changes to the data using the multi-function button or by "EDITOR for LA series" (free software downloadable from PATLITE website), the signal tower status may not be acquired properly. To ensure that it functions properly, please refer to section "4.5. Main Unit Setup" and synchronize the settings data.

Data that can be acquired

Categories	Description	Data type (JSON format)	
Input	Status of Input 1 ~ 8. 0: OFF, 1: ON	Decimal Number	
Mode	Mode of operation (SignalTowerMode or SmartMode)	String	
LED Unit Status	LED unit control status. 0: Off, 1: On, 2: Flashing	Decimal Number	
LED Unit Color	LED unit color information. #R _ G _ B _ ↑ 00H-FFH	String	
Buzzer Status	Buzzer pattern status.. 0: Stop, 1 ~ 11: Buzzer Pattern1 ~ 11 ※ 1	Decimal Number	
Smart Mode Status	Smart Mode status data can only be obtained when in Smart Mode. ※ 2		
	Group No.	Displays Group Number status. 1 ~ 31: Group No.1 ~ 31	Decimal Number
	Mute	Displays Mute status. 0: OFF, 1: ON	Decimal Number
	STOP Input	Displays STOP Input status. 0: OFF, 1: ON	Decimal Number
	Pattern No.	Displays Pattern Number status. 1 ~ 63: Pattern No.1 ~ 63	Decimal Number
LED Unit Firmware Version	Displays firmware version of the LED unit. □ . □ □ ↑ 0-9	String	
LAN Unit Firmware Version	Displays firmware version of the LAN unit. □ . □ □ ↑ 0-9	String	
MAC Address	Displays the MAC Address of this product. □ : □ : □ : □ : □ : □ ↑ 00H-ffH	String	

Specification of acquired data

Modified Code	LF
Indent	4 spaces
Character encoding	UTF-8

MEMO

- ※ 1 When multiple buzzer patterns are ON simultaneously, Buzzer Pattern 3 is prioritized.
- ※ 2 When operating in Signal Tower Mode, Smart Mode data is not acquired.
 - The LED colors are recorded in RGB color mode. (Refer to "Correspondance table of RGB color model" on page 102)
 - In Smart Mode, there is no OFF function for the LED units. If the LED units are OFF in Smart Mode, it will be recorded as Black On or Black Flashing.
 - The pattern number is recorded as 0 (00H) in the following conditions:
 - » When running in Smart Mode with the STOP function ON.
 - » When turning the STOP function ON during takt time overdue. (For a group that is set to repeat.)
 - When the pattern number is 0, 0 (00H) is recorded for both the LED units and buzzer.

Example of acquired data

[MAC address of this machine] 80:39:E5:00:1A:2F [Mode] Smart Mode (Time-trigger Type)
[LED unit] 1st Tier: Red On, 2nd Tier: Yellow On, 3rd Tier: Green On, 4th Tier: Blue On, 5th Tier: White On [Buzzer] Pattern 1,
[Input] Input 1,3,4 are ON [Group No.] No.1 [Pattern No.] No. 31 [STOP Input] OFF [Mute Input] OFF
[LED Unit Version] 1.00 [LAN Unit Version] 1.07

<text>

Transmission Data Format

<http://192.168.10.1/api/status?format=text>

Acquired data

Input : 10110000
Mode : SmartMode
Status1 : 1
Status2 : 1
Status3 : 1
Status4 : 1
Status5 : 1
Color1 : #FF0000
Color2 : #FFCC00
Color3 : #00FF00
Color4 : #0033FF
Color5 : #FFFFFF
Buzzer Pattern : 1
Smart Mode
Group : 1
Mute : 0
STOP : 0
Pattern : 31
LED Unit Version : 1.00
LAN Unit Version : 1.07
MAC Address : 80:39:e5:00:1a:2f

<json>

Transmission Data Format

<http://192.168.10.1/api/status?format=json>

Acquired data

```
{
  "Input": [1, 0, 1, 1, 0, 0, 0, 0],
  "Mode": "SmartMode",
  "Unit_Status": [1, 1, 1, 1, 1],
  "Unit_Color": ["#FF0000", "#FFCC00", "#00FF00", "#0033FF", "#FFFFFF"],
  "Buzzer_Pattern": 1,
  "SmartMode": {
    "Group": 1,
    "Mute": 0,
    "STOP": 0,
    "Pattern": 31
  },
  "LED_Unit_Version": "1.00",
  "LAN_Unit_Version": "1.07",
  "MAC_Address": "80:39:e5:00:1a:2f"
}
```

5.9. Signal Tower Information Transmission Function

Send the Signal Tower Information from LA6-POE. By using "Visualization application software", you can use collected Signal Tower Information to visualization.

What is About Visualization application software ?

Application software installed on the PC. Use this application to display information collected by LA6-POE in a Gantt chart or graph.

Must be provided by the customer.

(Refer to "5.9.8 Visualization Application Software" on page 83)

5.9.1. System Overview

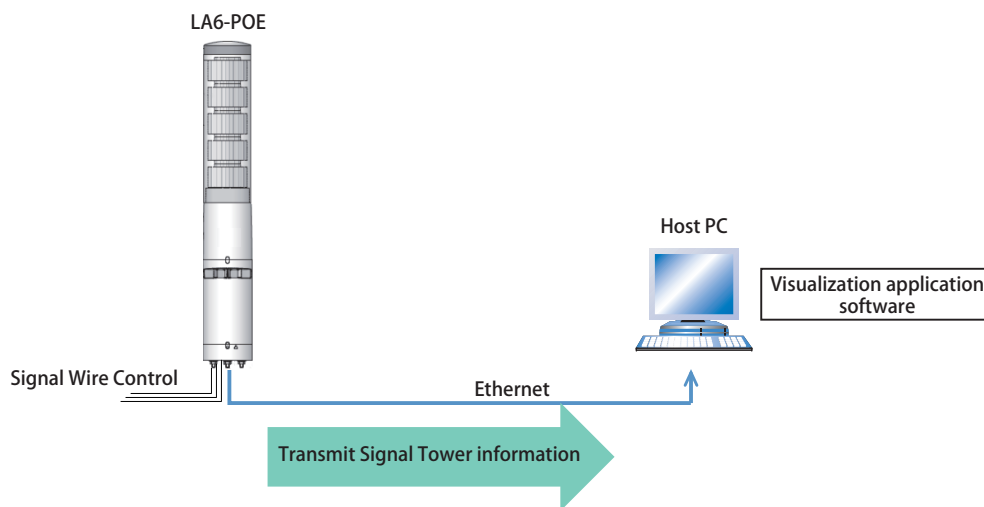

5.9.2. Communication specifications

LA6-POE will automatically TCP connection to the receiver (ex: Visualization application software) , and Signal Tower Information is transmitted when status changes occurs.

Automatic reconnection every 3 seconds when LA6-POE cannot connect or disconnect to receiver.

5.9.3. Transmission condition

Signal Tower Information is transmitted when the following conditions.

- When the signal input status changes "light on".
- When the signal input status changes "light off".
- When the signal input status changes "flashing".
- When the smart mode executed.
- When the smart mode pattern transitioned.
- When a takt time over occurred.
- When connected to receiver.
- When Mute input, STOP input and Clear input changed ON.

5.9.4. Transmission Data Contents

Send the following data.

- Signal Tower status information.
- Signal Tower color information.
- Smart Mode status information (Group Number, Mute, STOP Input, Pattern Number)
- Takt time overdue information.
- MAC address of this product.

5.9.5. Transmission Data Format

Data Format

Product Category AB		Identifier	Open	Data Size		Data Area
41H	42H	00H	00H	00H	20H or 25H	See Below

Product Category

The product is classified in "AB."

Identifiers

00H is fixed.

Data Size

The number of bytes for the data area is stored.

- When in Signal Tower Mode, the data size is 20H.
- When in Smart Mode, the data size is 25H.

Data Area

The Signal Tower Information is stored.

<< When running in Signal Tower Mode >>

1	2	3	4	5	6	7	8	9	10	11
MAC address						Mode	Time counter		Open	Packet No.
The MAC address of this product is stored.						00H : Signal Tower mode	0000H - FFFFH		00H	00H - FFH

12	13	14	15	16	17	18	19
1st Tier of LED unit				2nd Tier of LED unit			
Status	R	G	B	Status	R	G	B
00H: Off 01H: On 02H: Flashing	00H-FFH	00H-FFH	00H-FFH	00H: Off 01H: On 02H: Flashing	00H-FFH	00H-FFH	00H-FFH

20	21	22	23	24	25	26	27
3rd Tier of LED unit				4rd Tier of LED unit			
Status	R	G	B	Status	R	G	B
00H: Off 01H: On 02H: Flashing	00H-FFH	00H-FFH	00H-FFH	00H: Off 01H: On 02H: Flashing	00H-FFH	00H-FFH	00H-FFH

28	29	30	31	32
5th Tier of LED unit				Buzzer
Status	R	G	B	Status
00H: Off 01H: On 02H: Flashing	00H-FFH	00H-FFH	00H-FFH	00H: Stop 01H: Buzzer Pattern 1 02H: Buzzer Pattern 2 03H: buzzer sounds when the buzzer inputs are simultaneously entered

<< When running in Smart Mode >>

1	2	3	4	5	6	7	8	9	10	11
MAC address						Mode	Time counter		Open	Packet No.
The MAC address of this product is stored.						01H : Smart mode	0000H - FFFFH		00H	00H - FFH

12	13	14	15	16
Smart Mode Status				
Group No.	Mute	STOP Input	Pattern No.	Takt Time Overdue
01H: Group 1 02H: Group 2 (Cont) 1EH: Group 30 1FH: Group 31	00H: Mute Off 01H: Mute ON	00H: STOP OFF 01H: STOP ON	01H: Group 1 02H: Group 2 (Cont) 3EH: Group 62 3FH: Group 63	00H: Not occurred 01H: Occurred

17	18	19	20	21	22	23	24
1st Tier of LED unit				2nd Tier of LED unit			
Status	R	G	B	Status	R	G	B
01H: On 02H: Flashing	00H-FFH	00H-FFH	00H-FFH	01H: On 02H: Flashing	00H-FFH	00H-FFH	00H-FFH

25	26	27	28	29	30	31	32
3rd Tier of LED unit				4rd Tier of LED unit			
Status	R	G	B	Status	R	G	B
01H: On 02H: Flashing	00H-FFH	00H-FFH	00H-FFH	01H: On 02H: Flashing	00H-FFH	00H-FFH	00H-FFH

33	34	35	36	37
5th Tier of LED unit				Buzzer
Status	R	G	B	Status
01H: On 02H: Flashing	00H-FFH	00H-FFH	00H-FFH	00H: Stop 01H: Buzzer Pattern 1 02H: Buzzer Pattern 2 03H: Buzzer Pattern 3 (Cont) 0AH: Buzzer pattern 10 0BH: Buzzer pattern 11

MEMO	<p>Time counter : After the Signal Tower status change occurs, it is time (in 100 ms) to the signal tower transmission information.</p> <p>When no group number is specified or the pattern is not executed, 0 (00H) is stored in the following values. Group Number ,Pattern Number , LED unit (Status, RGB), Buzzer.</p>
-------------	--

5.9.6. Determine Signal Tower Input

There are two types of decisions for signal tower inputs, Normal and Flashing.
If there is no flashing state, use "Normal".

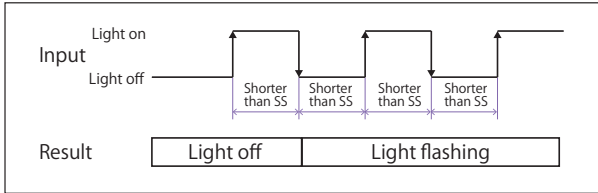
Setting	Determination	Description
Normal	Light on	When the signal input status changes from "Light off" to "Light on", the result is "light on" and information is transmitted.
	Light off	When the signal input status changes from "Light on" to "Light off", the result is "light off" and information is transmitted.
Flashing*	Flashing	When the signal input repeatedly changes "Light on" to "Light off" to "Light on" to "Light off" and so on, the result is "Flashing" and information is transmitted. You can select from 3 different time periods in Web setup tool before flashing is determined. <ul style="list-style-type: none"> • Flashing (short) • Flashing (medium) • Flashing (long)
	Light on	When the signal input status changes from "Light off" to "Light on", the result is "Light on" and information is transmitted.
	Light off	When the signal input status changes from "Light on" to "Light off", the result is "Light off" and information is transmitted.
	<p>* Flashing is determined when there are two status changes within a defined period. This period is called "SS seconds".</p>  <p>You can select "SS seconds" from three different time periods.</p> <ul style="list-style-type: none"> • Flashing (short): SS seconds = 0.7 seconds • Flashing (medium): SS seconds = 1.5 seconds • Flashing (long): SS seconds = 2.5 seconds 	

The status and determination operations are as follows. (Information in square brackets “[]” represent buzzer operation.)

Setting	Determination	Description	
		Change in state	Operation result
Normal	Light on	Light off → Light on	
	Light off	Light on → Light off	
Flashing	Flashing	Light off → Flashing	
		Light on → Flashing	
	Light on	Light off → Light on	
		Flashing → Light on	
	Light off	Light on → Light off	
		Flashing on → Light off	

5.9.7. Maintain Signal Tower Status

- When a transmission failure occurs between the signal tower and the Host PC, after that this function temporarily retains the transmission information in the product.
- Once communication is possible again, information that was retained is transmitted in sequential order from old to new.
- The function can retain up to 32 units of information.

5.9.8. Visualization Application Software

There are two ways the visualization application software to collect the Signal Tower information.

- Acquire with "Signal Tower Information Transmission Function".
- Acquire with "Detailed Status Acquisition Command".

■ Signal Tower Information Transmission Function

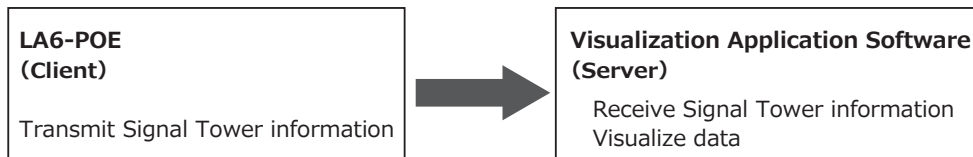

■ Detailed Status Acquisition Command.

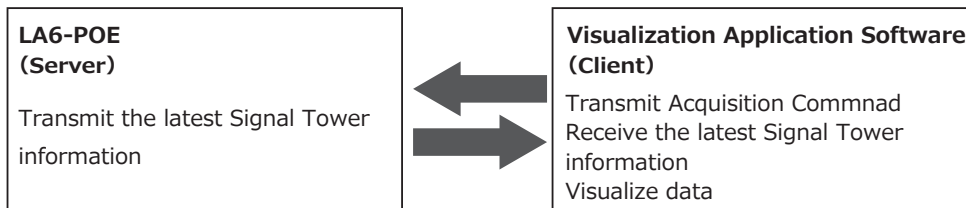

MEMO

When using software packages from PATLITE partners, please contact our sales office.

6. Maintenance

6.1. Initialization

Please proceed following steps when it is required for initialization.

- When you want to return to the factory settings.
- When you forget the IP address of this product.
- When you forget the Login Password of this product.

Initialization of this product can be done by the following methods.

- Initialize by operating the Multi-function button.
 "Initialize Network Settings" and "Initialize Setting Items" can be executed.
 * The Multi-function button is located inside the head cover of the LED unit.
 For details, refer to "2.2. Part Names and Dimensions".
- Initialize in the Web setting Screen.
 Either "Initialize settings other than network settings" or "Network settings are also re-initialized" can be executed.

Initialization Method	Selected initialization contents	Setting items that can be initialized (● is initialized)							
		Signal Tower mode setting	Buzzer Sound/ Volume	Flashing Cycle	Smart Mode Setup	Network Setup	Password	Control System	Command Configuration Modbus/TCP Setup Contact Input Operation Setting Mirroring Setup Signal Tower information transmission setup HTTP command receiving settings Security Settings
Multi-function Button	Initialization network settings	×	×	×	×	●	●	×	×
	Initialize setting items	●	×	×	×	●	●	●	●
WEB Setting Screen	Initialize settings outside network settings	×	×	×	×	×	●	●	●
	Network settings also re-initialize	×	×	×	×	●	●	●	●

[How to reinitialize by operating the Multi-function button]

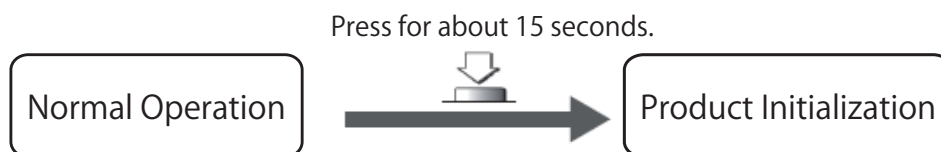

- When the Multi-function button is pressed and released after about 15 seconds, the LEDs of all the tiers flash in blue and the network setting can be initialized.
- From the flashing blue status, pressing and holding the Multi-function button for about 2 seconds will initialize the network settings.
- When the Multi-function button is pushed briefly (about 0.5 seconds), from the blue flashing status, the LEDs of all the tiers will flash in red and the setting items can be initialized.
- From the red flashing status, by pressing and holding the Multi-function button for about a second, the setting items are initialized.
- When initialization is completed, it automatically restarts.

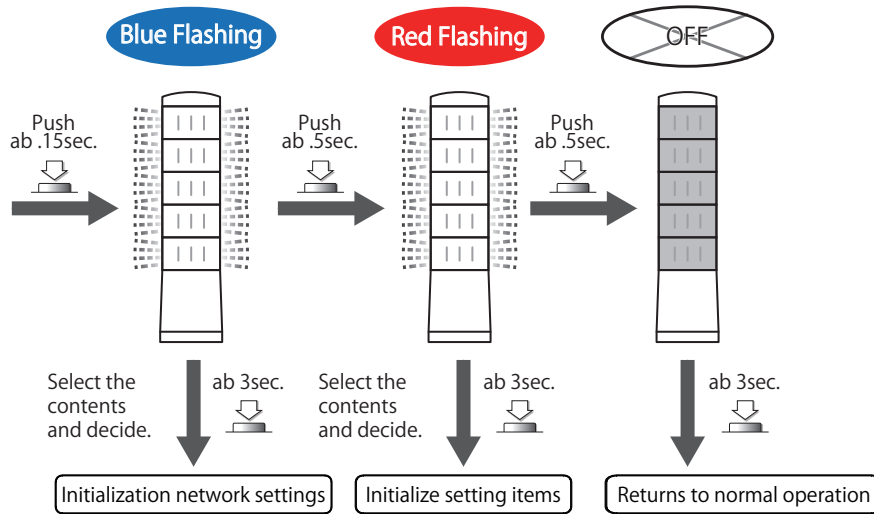

[How to initialize in the Web Setting Screen]

- ① Log into the Web Setting Screen. (Refer to "4.2.2 Login" on page 22.)
- ② Select "Initialization" from the menu items.
- ③ To also initialize the network settings, check "Reinitialize Network".
- ④ Click the "Initialization Execution" button.

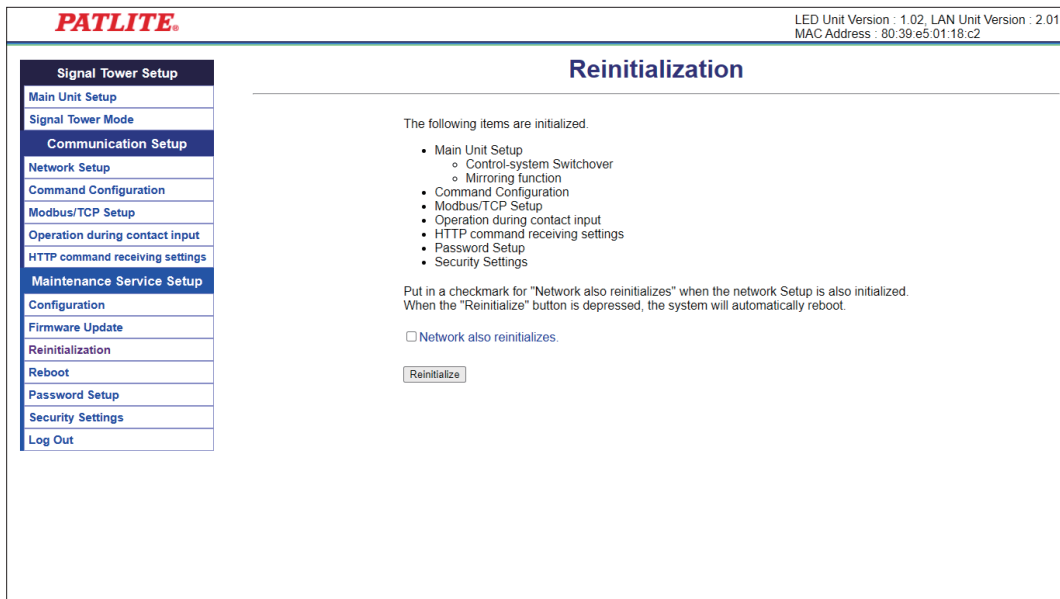

CAUTION

⚠ If the "Initialize network" is checked and initialization is executed, the network setting for this product will be reset to the default values, so network reconfiguration is required.

6.2. Reboot

Please proceed following steps when it is required for initialization.

- Mirroring does not display.
- Cannot operate Socket Communication.

Rebooting this product can be done by the following methods.

- Reboot in the Web setting Screen.
- Reboot via command control.

[How to reboot in the Web Setting Screen]

- ① Log into the Web Setting Screen. (Refer to "4.2.2 Login" on page 22.)
- ② Select "Reboot" from the menu items.
- ③ Click the "Reboot" button.

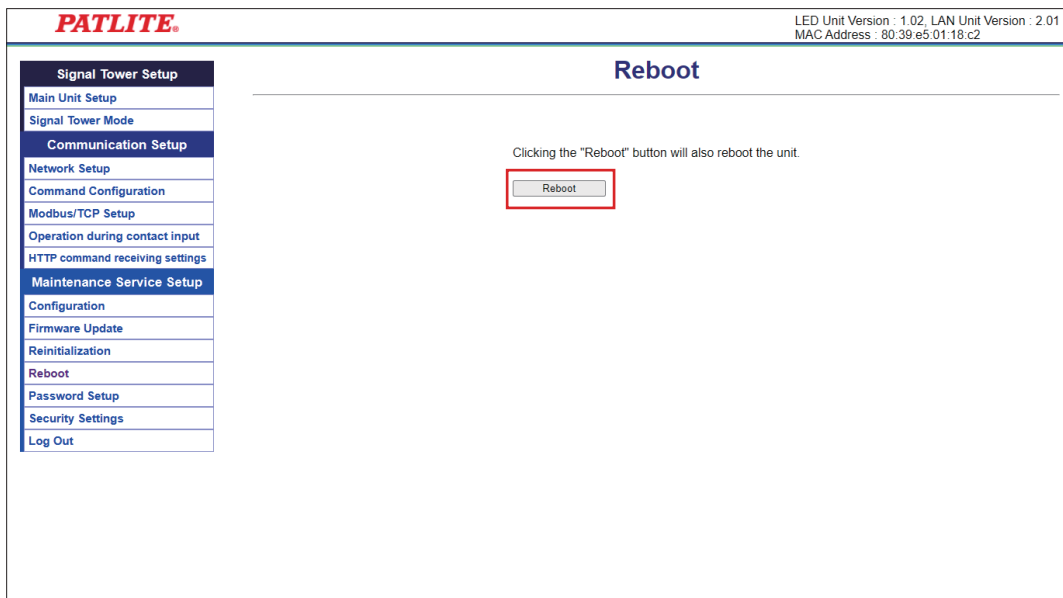

[How to reboot via command control]

This product can be rebooted by sending a PNS restart command.
Refer to "5.1 PNS Command" on page 37 for details.

6.3. Web Login Password Change

The password can be changed in the Web Setting Screen.

The password is used for the following applications.

- Log in to the Web Setting Screen.
- Adding to a Reboot command.

MEMO

Refer to 5.1.7. Reboot Command for details on the reboot command.

[The method to change a password]

- ① In the "Password setting" screen, enter the new password to change in the password field. (Single-byte alphanumeric characters 1 to 16 characters)
- ② Enter the new password the same way in the re-entry field, to verify the password was entered correctly.
- ③ When the "Set" button is pushed, the entered value will be set as the new password.

The screenshot displays the PATLITE web interface. At the top left is the PATLITE logo. At the top right, it shows 'LED Unit Version : 1.02, LAN Unit Version : 2.01' and 'MAC Address : 80:39:e5:01:18:c2'. On the left side, there is a navigation menu with categories: 'Signal Tower Setup' (Main Unit Setup, Signal Tower Mode), 'Communication Setup' (Network Setup, Command Configuration, Modbus/TCP Setup, Operation during contact input, HTTP command receiving settings), and 'Maintenance Service Setup' (Configuration, Firmware Update, Reinitialization, Reboot, Password Setup, Security Settings, Log Out). The main content area is titled 'Password Setup' and contains two input fields: 'Password' and 'Re-enter Password'. Below these fields is a 'Set' button.

6.4. Version Confirmation

The version of this product can be checked by the following methods.

- Operate the Multi-function button to confirm.
- Check in the Web Setting Screen.
- HTTP Detailed Status Acquisition Command

This product has an LED unit section and LAN unit section, in which each version is available separately.

Confirming the version of the LED unit	Multi-function button Web setting screen HTTP Command
Confirming the version of the LAN unit	Web setting screen HTTPCommand

[How to check in the Web Setting Screen]

Log into the Web Setting Screen for this product.

MEMO

For details on how to log in to the Web setting screen, refer to "4.2.2. Login".

On the upper part of the screen, the LED unit version and LAN unit version are displayed.
The MAC Address of this product is displayed under the version.

The screenshot shows the PATLITE web interface. At the top right, a status bar displays the following information:

- LED Unit Version : 1.02
- LAN Unit Version : 2.01
- MAC Address : 80:39:e5:01:18:c2

Callout boxes identify these fields as 'LED unit version', 'LAN unit version', and 'MAC Address'. The main configuration area is titled 'Main Unit Setup' and includes the following settings:

- Buzzer Sound: 1
- Control-system Switchover: Command Control
- Mirroring function: Enabled Disabled

Below these settings is a 'Set' button. At the bottom, there is a section titled 'Synchronized LED Unit Setup Data to LAN Unit' with a 'Sync' button.

[How to check the LED unit section version with the Multi-function button]

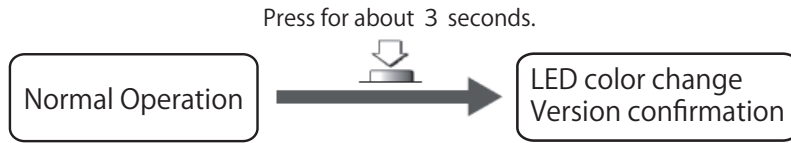

When the Multi-function button is pressed for about 3 seconds and released, the LEDs on all the tiers flicker in green and the LED color change and version can be checked.

As shown in the figure below, each time the Multi-function button is pressed briefly (about 0.5 seconds), 3 types of LED color changes, version check, and return to normal status can be selected.

When the Multi-function button is pushed briefly (about 0.5 seconds) from the green flashing status, all the LED tiers will flash in white.

From the flashing white status, if the Multi-function button is pressed and held for about 3 seconds, the version confirmation status is activated.

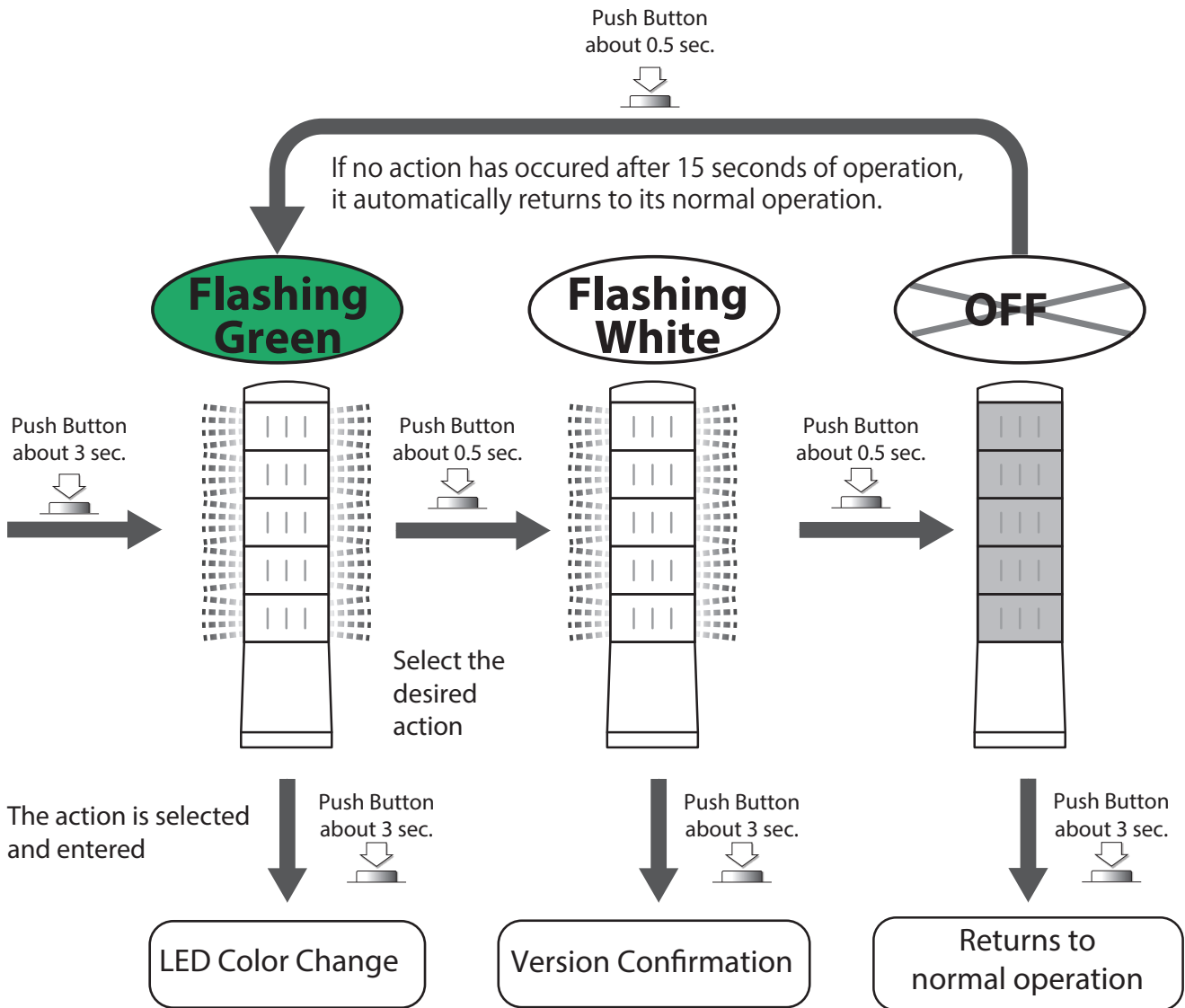

To verify the firmware version, three LED tiers will light up in accordance to the current firmware version, indicated from top to bottom. Refer to the following table for the meaning of each LED color.

LED Color	Corresponding Number
OFF	0
Red	1
Amber	2
Green	3
Blue	4
White	5
Purple	6
Pink	7
Sky Blue	8
Lemon	9

The version is expressed in the order from the LED top to bottom, as shown in the figure below.

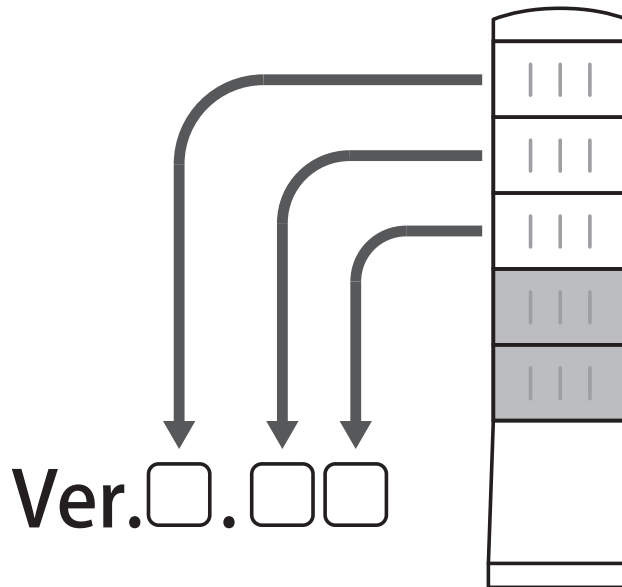

[How to check the version number using HTTP Command]

The version number of the LED and LAN units can be confirmed by sending an HTTP command. For details, refer to "5.8.2. HTTP Detailed Status Acquisition Command".

6.5. LED Color Change

The LED color can be changed from that of the default color when operating in the “Signal Tower Mode” and the Multi-function button for this product is pressed.

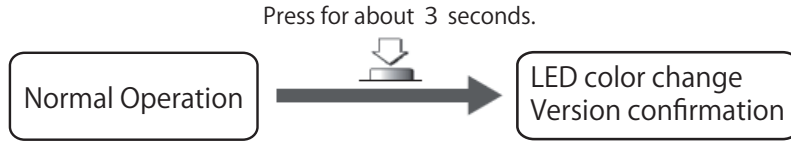

When the Multi-function button is pressed for about 3 seconds and released, the LEDs on all tiers flash in green and the LED color change and version confirmation can be checked.

As shown in the figure below, each time the Multi-function button is pressed briefly (about 0.5 seconds), 3 types of LED color changes, version check, and return to normal status can be selected.

From the flashing green status, if the Multi-function button is pressed and held for about 3 seconds, the LED color change function is activated.

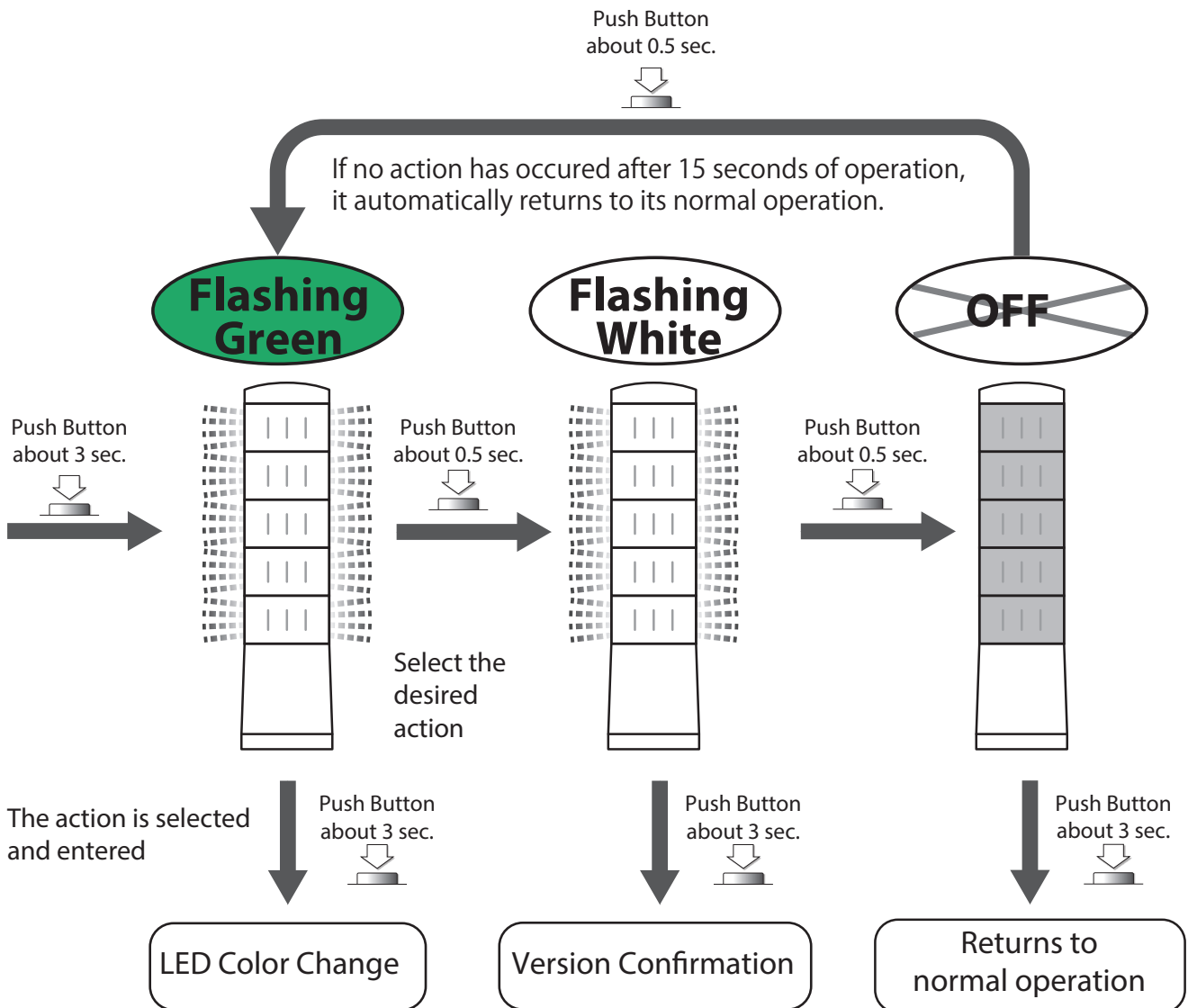

<LED Color Change>

The LED color which operates in the Signal Tower mode can be changed.

First, the LED color change starts from the 1st tier where the red LED turns on.

As shown in the figure below, whenever the Multi-function button is pushed for a short time (Ab. 0.5 sec.), the 1st tier of the LED lighting color changes in order.

With the desired color lit, if the Multi-function button is pressed a little longer (about 3 seconds), the LED color of the second tier can be changed to the desired color while the LED of the first tier remains lit with the selected color.

As with the first LED tier, change the LED color up to the last tier and push the Multi-function button a little longer (about 3 seconds) to complete the color change for all the LED tiers.

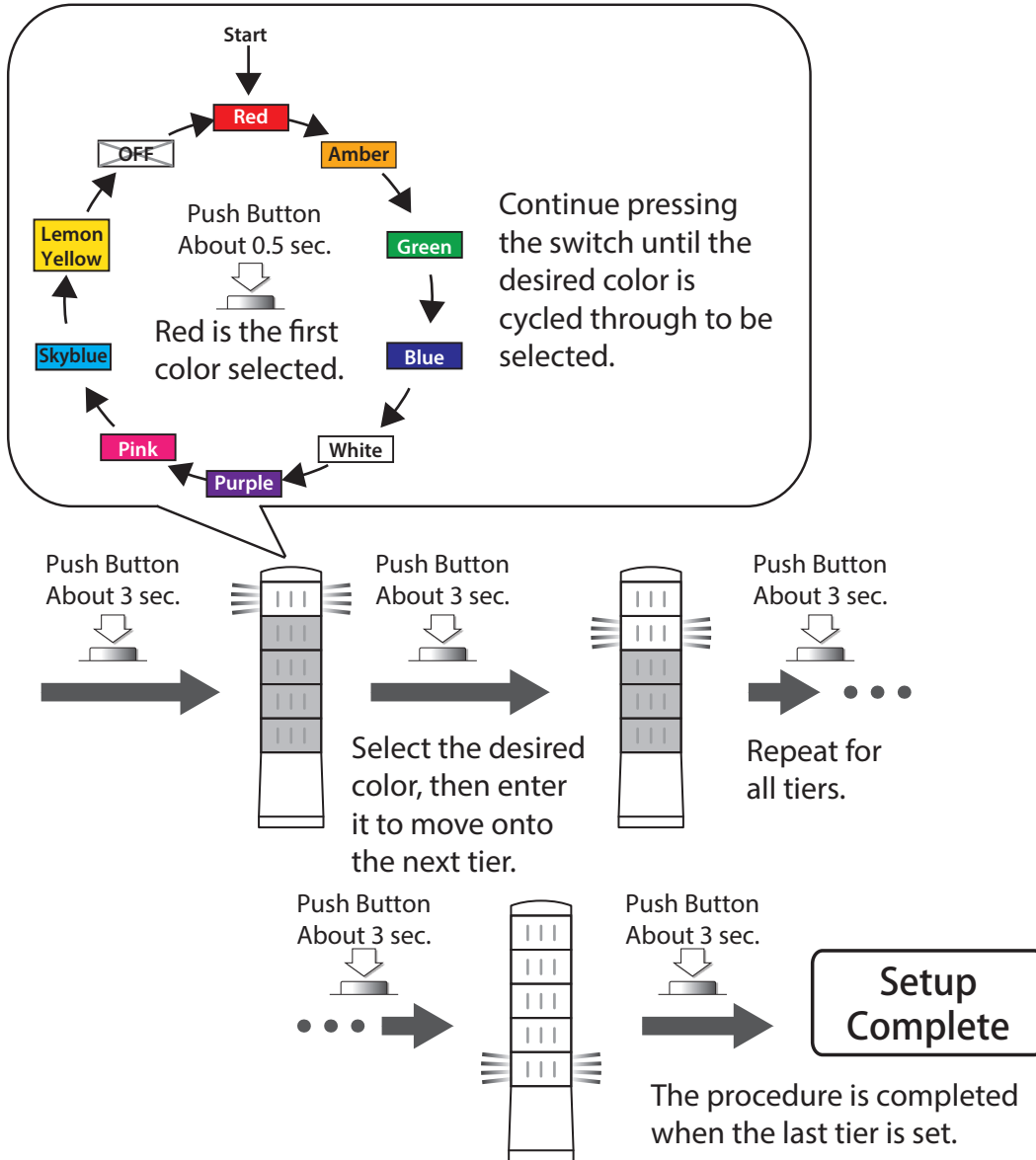

CAUTION

- ⚠ If there is a tier which does not change color, be sure to reset all tiers and do over.
- ⚠ None of the LED tier colors are saved until the last tier is set up.
- ⚠ If the operation is not done within 15 seconds or more, the LED colors return to normal operation without saving the selected LED colors.

6.6. Buzzer Sound Control

There are two ways to adjust the buzzer sound volume for this product; using the Web setting method and setting the button operation method. Refer to “4.5 Main Unit Setup” on page 28 for the method to set up via the Web Setting Screen.

The method to set up by operating the setting buttons is as follows.

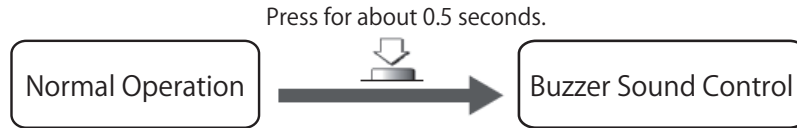

To adjust the buzzer volume, press the Mode Switch for a short time (about 0.5 seconds). Whenever the Mode Switch is pushed, the volume changes in the order according to the following figure, and a beep sound is heard with the changing of the volume. Volume adjustment is completed when the beep sound is done.

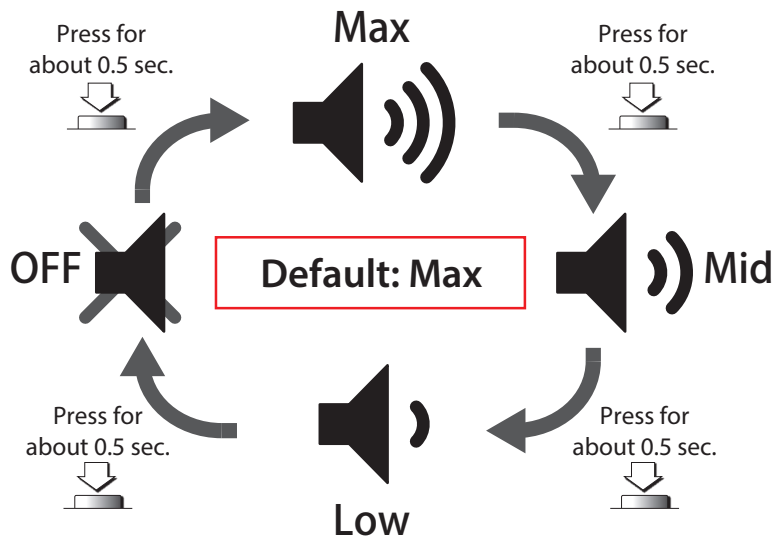

6.7. Language Data Update

This product can display up to two languages on the Web Setting Screen.

The default language is "English", but the language can be selected to display "Japanese".

By uploading language data to this product from the login screen, the language displayed in the Web setting screen can be changed.

- ① Click the "Language Upload" button. Up to two languages can be saved.

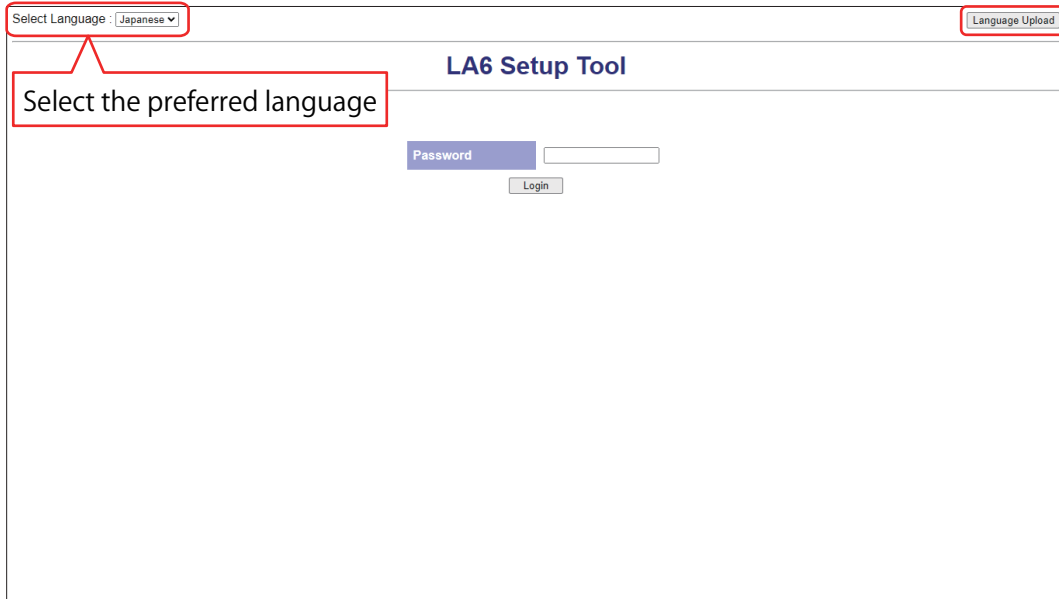

- ② The uploaded language is displayed on the screen.

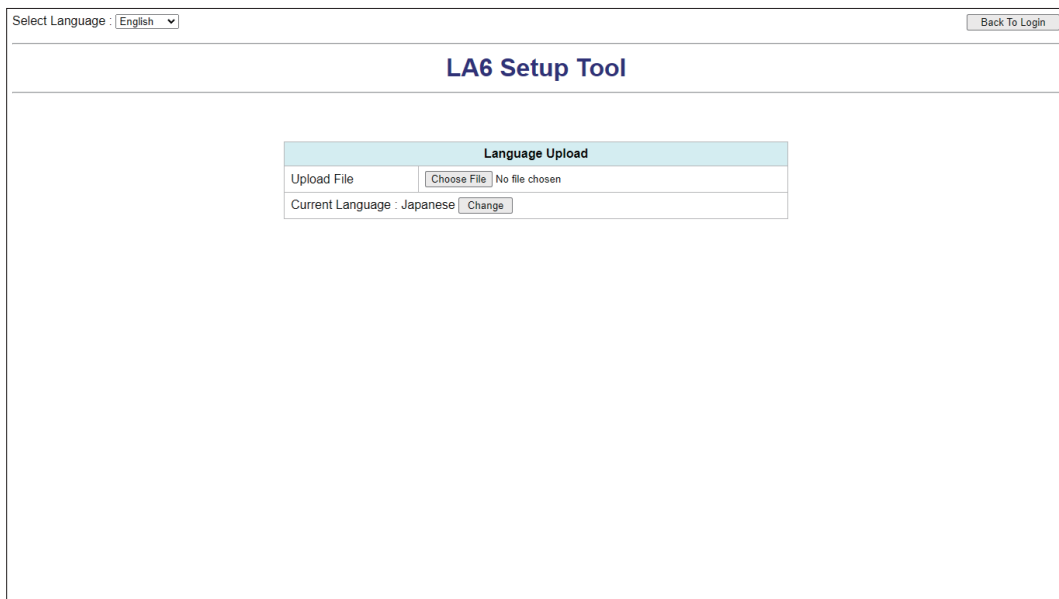

- ③ Select the uploaded language data to change to, then click the "Change" button.

MEMO When the language data is uploaded, English will not be replaced. The other language will be written and replaced.

<Rewriting Example>

```
graph LR; A["English  
Japanese"] -- "Upload French" --> B["English  
French"]; B -- "Upload German" --> C["English  
German"]
```

6.8. Firmware Update

6.8.1. Firmware update of the LED unit

The firmware can be updated in the Web Setting Screen.

[Update Method]

- ① Log into the Web Setting Screen.
- ② Select "Firmware Update" from the menu items.
- ③ In "Update LED Unit", Click the "Browse" button to select the firmware of the LED unit.
- ④ Clicking the "Update" button will start the firmware update.

When the update is complete, the product will reboot automatically.

PATLITE LED Unit Version : 1.02, LAN Unit Version : 2.01
MAC Address : 80:39:e5:01:18:c2

Firmware Update

After pressing the "Update" button, do not change the screen until the process has been completed.
Furthermore, absolutely do not disconnect the unit's power during the process.

Update LED Unit

Firmware No file chosen

Automatic reboot after saving

The update should take about 30 seconds to complete.

Update LAN Unit

Firmware No file chosen

Automatic reboot after saving

The update should take about 10 seconds to complete.

CAUTION

- ❗ After pressing the "Update" button, do not operate the Web Browser until firmware updates complete.
- ❗ Do not disconnect the unit's power or LAN cable during the update.
- ❗ Be sure to verify the object model and firmware version before executing an update.
If an object is not selected when the firmware is to be updated, it will result in a cause of failure to this product.

6.8.2. Firmware update of the LAN unit

The firmware can be updated in the Web Setting Screen.

[Update Method]

- ① Log into the Web Setting Screen.
- ② Select "Firmware Update" from the menu items.
- ③ In "Update LAN Unit", Click the "Browse" button to select the firmware of the LAN unit.
- ④ Clicking the "Update" button will start the firmware update.

When the update is complete, the product will reboot automatically.

PATLITE LED Unit Version : 1.02, LAN Unit Version : 2.01
MAC Address : 80:39:e5:01:18:c2

Signal Tower Setup

- Main Unit Setup
- Signal Tower Mode
- Communication Setup**
- Network Setup
- Command Configuration
- Modbus/TCP Setup
- Operation during contact input
- HTTP command receiving settings
- Maintenance Service Setup**
- Configuration
- Firmware Update
- Reinitialization
- Reboot
- Password Setup
- Security Settings
- Log Out

Firmware Update

After pressing the "Update" button, do not change the screen until the process has been completed.
Furthermore, absolutely do not disconnect the unit's power during the process.

Update LED Unit

Firmware No file chosen

Automatic reboot after saving

The update should take about 30 seconds to complete.

Update LAN Unit

Firmware No file chosen

Automatic reboot after saving

The update should take about 10 seconds to complete.

⚠ CAUTION

- ⚠ After pressing the "Update" button, do not operate the Web Browser until firmware updates complete.
If operated the Web Browser, please reboot this product before re-run the firmware update
- ⚠ Do not disconnect the unit's power or LAN cable during the update.
- ⚠ Be sure to verify the object model and firmware version before executing an update.
If an object is not selected when the firmware is to be updated, it will result in a cause of failure to this product.
- ⚠ Firmware Ver 2.00 or later cannot downgrade to less than Ver 2.00 firmware.

6.9. Security Settings

Select the protocol to be used when accessing the Web setting screen or controlling with HTTP commands with HTTP or HTTPS.

Register the certificate and private key used when selecting HTTPS.

Specification of Certificate and Private key.	
Certificate	PEM format. (Base 64 encoded X.509)
Private key	PEM format. (PKCS#1 and plain text)
MAX size of certificate and private key	4KB in total.

[How to Change Protocol]

- ① Log in to Web setting screen.
- ② Select "Security Settings" from the menu screen.
- ③ Select "HTTP" or "HTTPS" from "Protocol".
- ④ If you select "HTTPS", register the certificate used for HTTPS communication in "Certificate".
- ⑤ If you select "HTTPS," register the private key used for HTTPS communication with "Private key."
- ⑥ Click the "Set" button to set the selected protocol.

The unit will restart automatically when setting is completed.

The screenshot displays the PATLITE web interface for Security Settings. On the left, a navigation menu lists various setup options, with 'Security Settings' highlighted. The main content area is titled 'Security Settings' and includes the following elements:

- Protocol:** A dropdown menu currently set to 'HTTP', with 'HTTPS' also visible. A 'Set' button is positioned to the right.
- Certificate:** A field with a 'Choose File' button and the text 'No file chosen'.
- Private Key:** A field with a 'Choose File' button and the text 'No file chosen'.
- A 'Set' button is located at the bottom right of the form area.

At the top right of the interface, the following information is displayed: LED Unit Version : 1.02, LAN Unit Version : 2.01, and MAC Address : 80:39:e5:01:18:c2.

CAUTION

- ⚠ If you select https communication, when you access the Web Setup Screen or display a pop-up, sometimes an error screen with a message such as “This site is not secure” or “This connection does not protect privacy” will appear. When the error screen is displayed, in the browser click the [Details] link, then click [Go to Web page] to access the Web Setup Screen. (The displayed text differs depending on your browser and browser version.)
- ⚠ Be sure to register the correct combination of certificate and private key. If the wrong combination is registered, communication may be hindered.
- ⚠ Since HTTPS communication uses encrypted data communication, the response may be slower than HTTP communication.
- ⚠ Only TLS1.2 is supported as the encryption protocol for HTTPS communication.
- ⚠ Update the OS and browser versions to the latest version if communication via HTTPS cannot be accomplished.

7. Troubleshooting

If trouble is encountered while using this product, check the table below for applicable items and implement the contents described in "Cause / Countermeasure". If there is no applicable explanation, or if the "Cause/Countermeasure" can not be solved, contact your nearest PATLITE Sales Representative listed at the end of this book.

Problem	Cause/Countermeasure	Reference
The Web Setting Screen is not displayed.	Is the LAN cable connected correctly? Check that it is connected properly.	"3.1 How to Install", pg. 11
	Is the connected LAN cable a category 5e or higher? Use a LAN cable rated at category 5e or higher.	"3.2.4 LAN Cable Connection", pg. 16
	Is the IP address setup for this product correct? Check the IP address for this product.	"4.3 Network Setup", pg. 23
	Is the set IP address for this product duplicated with other equipment? Check the IP address for this product.	"4.3 Network Setup", pg. 23
	Is the IP address setup on the personal computer side set up wrong? Check the IP address for the personal computer.	—
	Is Java Script disabled in the browser security setting? Enable the Java Script. Clear the browsing history, then check it.	—
The Web Setting Screen is not displayed correctly.	Update the browser information, then check it.	—
When logging in the Web Setting Screen, an error is displayed.	Was the wrong IP address accessed? Check the IP address currently displayed in the address column of the browser.	—
"Unable to communicate with the LED Unit." is displayed on the WEB setting screen.	Is the DC power properly applied at the correct voltage? Be sure to use it with the proper voltage.	"10. General Specifications" on page 108
	Was this product booted while it was unable to communicate with a DHCP server? Check whether it can communicate with a DHCP server. Wait for a while before accessing the Web setting screen again.	—
	The LED unit may be faulty. Contact your nearest PATLITE Sales Representative	—
The LED does not light up or flash.	Is it connected to the PoE power supply? Connect it to the PoE power supply.	"3.2.4 LAN Cable Connection", pg. 16
	Is the power properly supplying the correct voltage? Check that the supply voltage is at the rated voltage.	—
	Is "BLACK" selected in the LED unit setting? Set a color to light up.	"4.4 LED Unit Setup", pg. 24
	Is the control method set up correctly? Make sure the setup matches the control method.	"4.5 Main Unit Setup", pg. 28
	Is the electric wiring connected correctly? Check whether the wiring is connected correctly.	"3.2 Wiring", pg. 13
A different LED tier from what I thought lights up when I make it turn on.	Is the setup data correct? Check that the contents of the setup data is correct.	"4.4 LED Unit Setup", pg. 24
	Is the electric wiring connected correctly? Check whether the wiring is connected correctly.	"3.2 Wiring", pg. 13

Problem	Cause/Countermeasure	Reference
The buzzer does not sound.	Is the buzzer sound set to "Mute"? Set the buzzer sound to an audible level.	"6.6 Buzzer Sound Control", pg. 93
	Is the "Buzzer: No sound" selected in the smart mode setting? Set up the desired buzzer pattern.	"EDITOR for LA series" help
	Is the power properly supplying the correct voltage? Please check that the supply voltage is at the rated voltage.	—
	Is the electric wiring connected correctly? Check whether the wiring is connected correctly.	"3.2 Wiring", pg. 13
The buzzer sound volume is small.	Is the buzzer volume set to minimum? Set the buzzer sound to an audible level.	"6.6 Buzzer Sound Control", pg. 93
	Is the setup data correct? Check that the contents of the setup data is correct.	"4.4 LED Unit Setup", pg. 24 "EDITOR for LA series" help
Cannot operate Socket Communication.	Is the communication port correct? Check the port number setting.	"4.6 Command Configuration", pg. 29 "4.7 Modbus/TCP Setup", pg. 30
	Is the communications protocol correct? Check the protocol setting.	"4.6 Command Configuration", pg. 29
	Is the transmitted data correct? Check the transmitted data.	"5.1 PNS Command", pg. 37 "5.2 PHN Command", pg. 50 "5.3 Modbus/TCP", pg. 52
The expected behavior cannot be controlled by Command.	Does this product receive the Modbus/TCP command? Check the equipment which has transmitted the Modbus/TCP command to this product.	"5.3 Modbus/TCP", pg. 52
IP address cannot be obtained automatically	If the DHCP server cannot be accessed, the network settings of the LA6-POE will operate with the default values. Check if the environment can connect to the DHCP server.	"4.3 Network Setup", pg. 23
The Signal Tower will not switch off, even if the "Clear" switch is pressed.	Is the control method set to the signal wire control method? Please set it to the command control method.	"4.5 Main Unit Setup", pg. 28
The LED flashes red in all tiers immediately after switching on the power.	The setting data is damaged. Rewrite the setting data.	"4.4 LED Unit Setup", pg. 24
The writing of the setting data failed.	Was the setting data for the LED unit and LAN unit written wrong? Make sure the setting data to be written is correct.	—
The firmware writing has failed.	Was the firmware for the LED unit and LAN unit written wrong? Make sure the firmware to the proper unit is written correctly.	—

Problem	Cause/Countermeasure	Reference
Mirroring does not display.	Is the mirroring destination set up for the signal line control method? Please set it to the command control method.	"4.9 Mirroring Setup", pg. 32
	Is the IP address for the mirroring destination set in the destination of the mirroring setting? Set the IP address correctly.	"4.9 Mirroring Setup", pg. 32
	Was the LAN cable linked to the product substituted for another HUB port? Reboot the HUB.	—
	Was the LED unit setting data read during the mirroring operation? Reboot this product.	—
The adhesive strength of this rubber sheet becomes weak.	Is there dirt or oil adhered to the rubber sheet to weaken it? Remove the bottom plate from the product, remove the dirt etc., with water, then dry it thoroughly before reuse.	"3.1 How to Install", pg. 11
The HTTP command cannot be controlled.	Are you logged in the Web Setting Screen? Please log out the Web Setting Screen.	—
	Is the control method set to the signal wire control method? Please set it to the command control method.	"4.5 Main Unit Setup", pg. 28
The transmission data of the signal tower information is different from what I set.	Are you writing the data via USB cable? Make sure that settings of the LED unit are synced properly.	"4.5 Main Unit Setup", pg. 28
The data obtained from a command is different from what is actually displayed on the unit.		
Cannot communicate via HTTPS.	Is the certificate or private key registered correctly? Please register the correct certificate and private key after initializing with the setting button.	"6.1 Initialization", pg. 84 "6.9 Security Settings", pg. 98

8. Replacement Parts

The replacement parts list for this products is shown in the table below. When replacement parts are necessary, direct your inquiries to the store where this product was purchased.

Head Cover
USB Cover
Waterproofing Ring B (2 pc. set)
LAN bracket assembly
Rubber sheet (3 pcs.)
Terminal connector

9. Option Parts

9.1. Wall-mount Bracket (Direct Mounting Type [TN])

Supported Option Model	SZK-003W
------------------------	----------

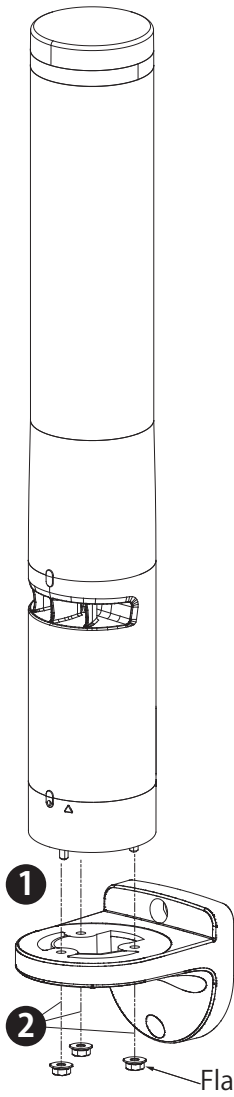

1 Place the product (LA 6 - 5 DTNWB - POE) directly onto the wall-mount bracket (SZK - 003W) as shown on the left.

2 Secure the product with flanged nuts (3 pieces) included with the product.

Recommended Torque

0.75N/m (Standard)

CAUTION

- ⚠ Be sure to use both mounting screws and to tighten them with the recommended torque.
- ⚠ The clamping surface should be level and sufficient enough to tolerate shock, vibrations and the weight of the product.

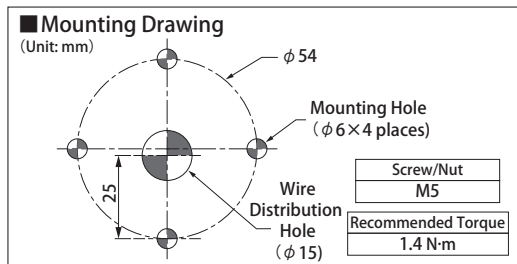

Flanged Nut (M3) (3 pieces)

MEMO

For details of the wall-mount Bracket (SZK - 003W), refer to the operation manual for the wall-mount Bracket (SZK - 003W).

9.2. Wall-mount Bracket (Stationary Type [SN])

Supported Option Model	NH-WST2
------------------------	---------

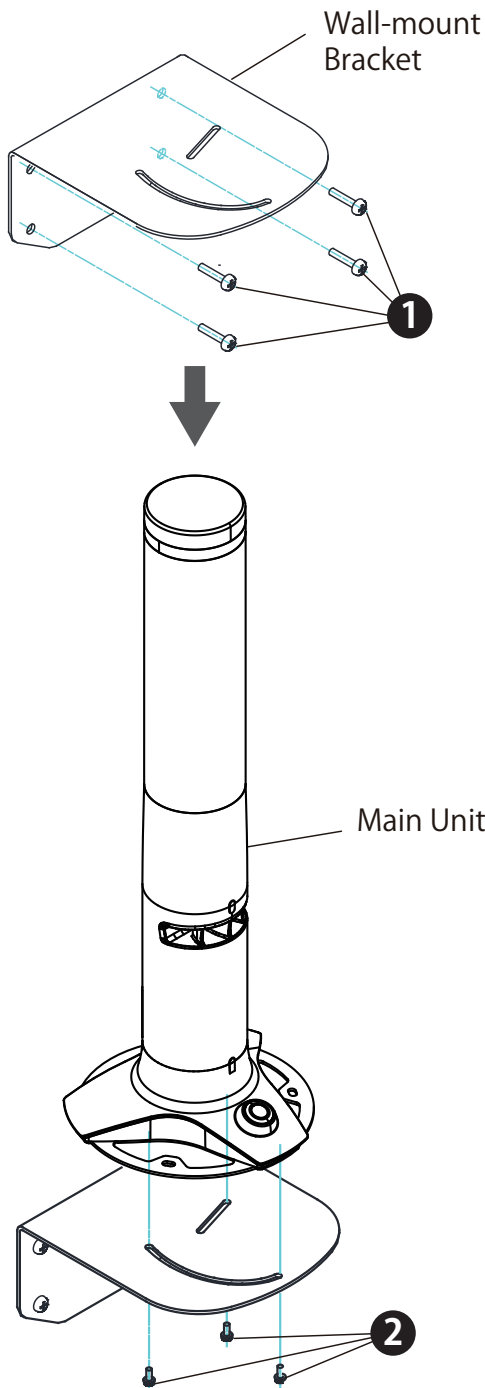

- 1 Use 4 M5 screws (or equivalent) to mount the Wall-mount Bracket (NH - WST 2). Adjust the bolting torque in accordance with the quality of the surface material of the wall, or the screw length.

CAUTION

- ⚠ The clamping surface should be level and sufficient enough to tolerate shock, vibrations and the weight of the product.
- ⚠ All four mounting screws should be used.

MEMO

- The screws needed to mount to the surface of the wall is not included.
- The customer needs to supply the mounting screws in accordance to the construction material of the wall surface to be mounted on.

- 2 Using the three mounting screws supplied with the wall mounting bracket (NH - WST 2), attach the product (LA 6 - 5 DSNWB - POE) to the NH - WST 2 as shown on the left.

Recommended Torque

0.6N/m (Standard)

CAUTION

- ⚠ Be sure to use both mounting screws and to tighten them with the recommended torque.

MEMO

- Don't use the protective sheet provided with the wall-mount bracket.
- Attach the rubber sheet to the product without it sticking onto the bottom plate.

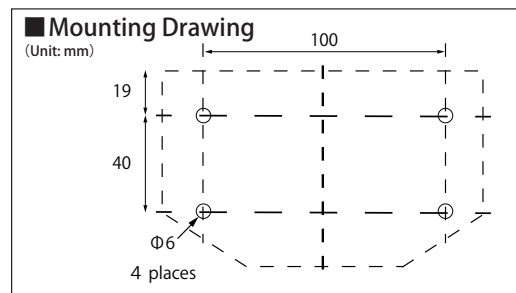

9.3. Upper Bracket (Direct Mounting Type [TN])

Supported Option Model SZP-004

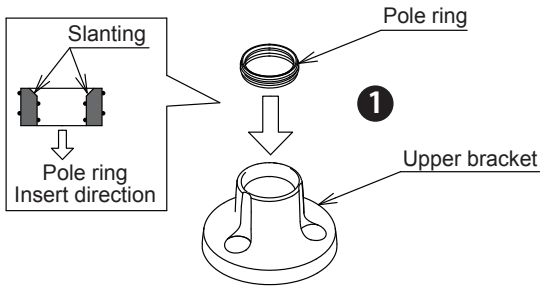

1 Insert the supplied pole ring into the upper bracket.

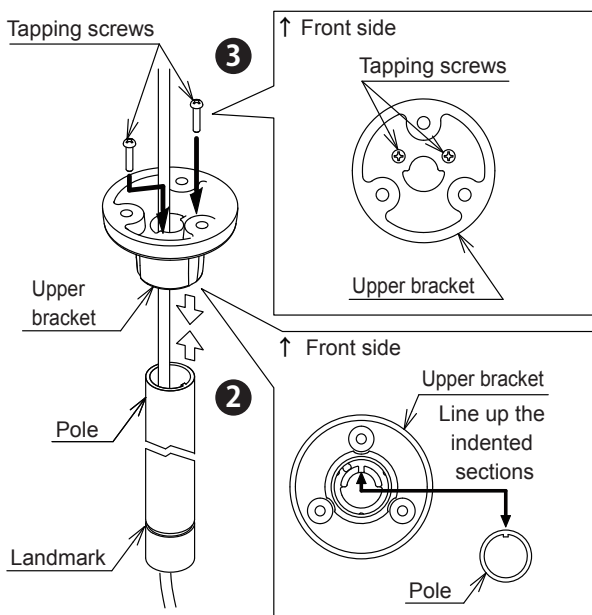

2 Insert the pole into the upper bracket, lining up the indentations.

3 In two positions, use the tapping screws secure the upper bracket and pole.

Recommended torque
1.4N·m

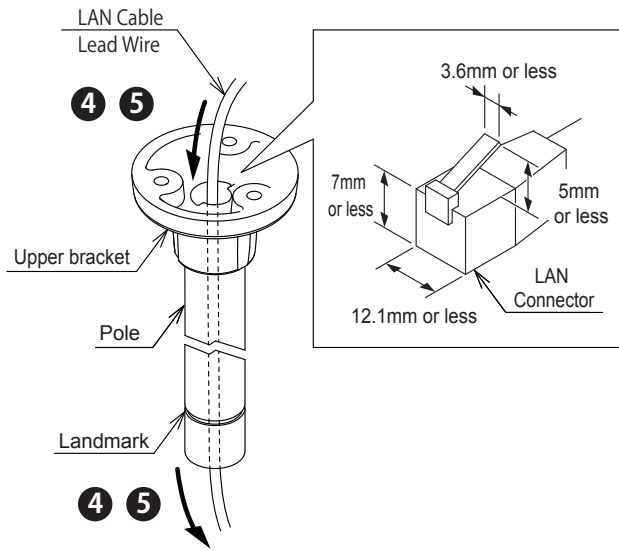

4 First thread the cable from the top of the upper bracket, and pull out the cable from the side of pole landmark.

5 Thread the lead wire from the top upper bracket, and pull out the lead wire from the side of pole landmark.

MEMO

- The LAN cable you can pass through the upper bracket is limited by the size of its connector.
- LAN cables with a protective cover on the connector cannot be used.
- Insert the LAN cable first.

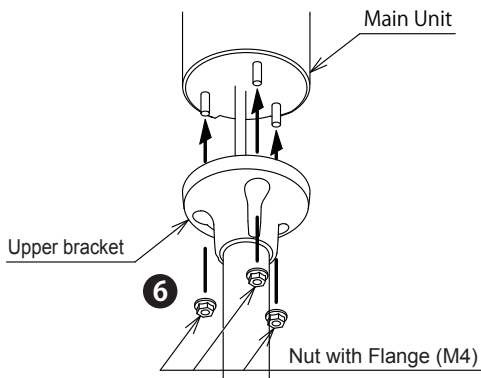

6 Assembling the Upper Bracket and the product. In 3 places, affix the nuts included with the product, to secure the upper bracket and unit.

Recommended torque
0.6N·m

10. General Specifications

Model		LA6-5DTNWB-POE
Rated Voltage		DC24V
Power over Ethernet (PoE)		DC48V
Operating Voltage Range		DC24V ±10%
Power over Ethernet (PoE)		DC36 - 57V
Rated Current Consumption	Typ.	DC24V supply: 0.30A; PoE at DC48V supply: 0.18A ※ 1
	Max.	DC26.4V supply: 0.49A; PoE at DC48V supply : 0.26A ※ 1
Rated Power Consumption	Typ.	DC24V supply: 7.2W; PoE at DC48V supply: 8.6W ※ 1
	Max.	DC26.4V supply: 12.9W; PoE at DC48V supply: 12.5W ※ 1
Signal Wire Current		DC26.4V supply: 420mA ※ ¹ /70mA ※ ² ; PoE at DC48V supply: 10mA ※ 1
Operating Ambient Temperature		-10°C - +50°C
Operating Ambient Humidity		Less than 90%RH (No condensation)
Storage Ambient Temperature		-10°C - +50°C
Storage Ambient Humidity		Less than 90%RH (No condensation)
Mounting Location		Indoors
Mounting Direction		Upright
Protection Rating		IP54 (IEC 60529)
Environmental Condition		Upright
Vibration Resistance		10m/s ² (JIS C 60068-2-6)
Environmental Condition		Upright
Insulation Resistance		More than 1MΩ at 500VDC Between live part and non-current carrying metallic part
Withstand Voltage		500VAC applied for 1min between live part and non-current carrying metallic part without breaking insulation
Mass (Tolerance ±10%)		630g
Outer Dimensions		Refer to "2.2. Part Names and Dimensions" on page 10
LED Tiers		5
Display Color Variations		Signal Tower Mode: 9 Colors / Smart Mode: 21 Colors
Sound Pressure Level		85dB or more
Environmental Condition		Maximum volume, Buzzer Sound No.1 measured from the front direction of the buzzer aperture at 1m
"Buzzer Sound (Typical Frequency)"	No.1	2400Hz Continuous beep sound
	No.2	2400Hz Rapid intermittent beep (0.05 sec. sound / 0.05 sec. silence)
	No.3	2400Hz Long intermittent beep (1.5 sec. sound / 1.5 sec. silence)
	No.4	2400Hz Fast intermittent beep (0.5 sec. sound / 0.5 sec. silence)
	No.5	3600Hz Continuous beep Sound
	No.6	3600Hz Rapid intermittent beep (0.05 sec. sound / 0.05 sec. silence)
	No.7	3600Hz Long intermittent beep (1.5 sec. sound / 1.5 sec. silence)
	No.8	3600Hz Fast intermittent beep (0.5 sec. sound / 0.5 sec. silence)
	No.9	2400Hz & 3375Hz Multiplexed Beep (0.25 sec. / 0.25 sec.)
	No.10	2400Hz & 3600Hz Multiplexed Beep (0.25 sec. / 0.25 sec.)
	No.11	4000Hz & 4800Hz Multiplexed Beep (0.25 sec. / 0.25 sec.)
Volume Control		The set up button is the fourth step (Factory Default: Maximum, Switchable by Web setup tool) [Maximum] -> [-5dB drop from maximum (standard)] -> [-10dB drop from maximum (standard)] -> [OFF] (-> Returns to [Maximum]) Switchable by Web setup tool

※ 1 Environmental Condition: All tiers lighting Amber, buzzer sounding Buzzer No.1 at maximum volume.

※ 2 Environmental Condition: Tier 1 lighting Amber with no sound.

Model		LA6-5DTNWB-POE
Luminous Intensity (typ) ※ 3		Red (1000mcd), Amber (1700mcd), Green (2600mcd), Blue (1000mcd), White (1250mcd) Purple (800mcd), Pink (850mcd), Lemon (2150mcd), Sky blue (2150mcd)"
Flashing Rate		"30±2 Flashes Per Minute, 60±2 Flashes Per Minute, 120±2 Flashes Per Minute (Factory Default: 60 Flashes Per Minute) Switchable by Web setup tool"
Interface	Power/Contact Input	Screwless Terminal Block (Number of Contacts: 12) Wire Diameter: 0.2 -1.5mm ² (Solid Wire), AWG24-16 (Stranded Wire) "Power: 2(DC24V) Contact Input: (External relay/NPN/PNP): 8 Flashing/Pulse Enable: 1 COM: 1"
		LAN
	PoE	Corresponding to IEEE802.3af Class 0 Conformity
	Communication Method	Ethernet (IEEE802.3 Conformity)
	Physical Layer	10BASE-T/100BASE-TX (Auto-MDI/MDIX)
	Data Link Layer	CSMA/CD
	Network Layer	IP/ARP/ICMP
	Transport Layer	TCP/UDP
	Application Layer	HTTP/HTTPS/DHCP/Modbus TCP/Socket (Corresponds to PHN/PNS Commands)
	USB	USB micro-B Terminal USB2.0
Operation Part		Multi-function Button (Set in Head Cover)
Indicator Light		None
Various Settings		Switchable by Web setup tool
Operational Method		Signal Wire Control/Command Control
Accessory		Hexagon Nut with Flange (M4) 3pcs, Screw (M4×20) 3pcs
Optional Parts		Installation Bracket (SZW-060W), Wallmount Bracket (SZK-003W), Upper Bracket (SZP-004 □)
Connectable LAN cable		Category 5e or higher (Both Straight Cable and Cross Cable can be used)
Conformity Standards		RoHS Directive (EN 50581) EMC Directive (EN 61000-6-4, EN 61000-6-2, EN55032 Class A, EN55024) FCC Part 15 Subpart B Class A, ICES-003 Class A KC (KN 61000-6-4, KN 61000-6-2) UL 508, CSA-C22.2 No.14 Recognized Component (File No.E215660) ※ DC24V supply only UL 60950-1, CAN/CSA C22.2 No. UL60950-1-07 Recognized Component (File No.E480103)
Remarks		CE Marking
※ 3 Due to the characteristics of the LED elements, a variation in difference of the color tone and brightness of every product may occur."		

Model		LA6-5DSNWB-POE
Rated Voltage		DC24V
Power over Ethernet (PoE)		DC48V
Operating Voltage Range		DC24V ±10%
Power over Ethernet (PoE)		DC36 - 57V
Rated Current Consumption	Typ.	DC24V supply: 0.30A; PoE at DC48V supply: 0.18A ※ 1
	Max.	DC26.4V supply: 0.49A; PoE at DC48V supply : 0.26A ※ 1
Rated Power Consumption	Typ.	DC24V supply: 7.2W; PoE at DC48V supply: 8.6W ※ 1
	Max.	DC26.4V supply: 12.9W; PoE at DC48V supply: 12.5W ※ 1
Signal Wire Current		DC26.4V supply: 420mA ※ ¹ /70mA ※ ² ; PoE at DC48V supply: 10mA ※ 1
Operating Ambient Temperature		-10°C - +50°C
Operating Ambient Humidity		Less than 90%RH (No condensation)
Storage Ambient Temperature		-10°C - +50°C
Storage Ambient Humidity		Less than 90%RH (No condensation)
Mounting Location		Indoors
Mounting Direction		Upright
Protection Rating		IP20 (IEC 60529)
Environmental Condition		Upright
Vibration Resistance		None
Insulation Resistance		More than 1MΩ at 500VDC between live part and non-current carrying metallic part.
Withstand Voltage		500VAC applied for 1min between live part and non-current carrying metallic part without breaking insulation.
Mass (Tolerance ±10%)		780g
Outer Dimensions		Refer to "2.2. Part Names and Dimensions" on page 10
LED Tiers		5
Display Color Variations		Signal Tower Mode: 9 Colors / Smart Mode: 21 Colors
Sound Pressure Level		85dB or more
Environmental Condition		Maximum volume, Buzzer Sound No.1 measured from the front direction of the buzzer aperture at 1m
"Buzzer Sound (Typical Frequency)"	No.1	2400Hz Continuous beep sound
	No.2	2400Hz Rapid intermittent beep (0.05 sec. sound / 0.05 sec. silent)
	No.3	2400Hz Long intermittent beep (1.5 sec. sound / 1.5 sec. silent)
	No.4	2400Hz Fast intermittent beep (0.5 sec. sound / 0.5 sec. silent)
	No.5	3600Hz Continuous beep Sound
	No.6	3600Hz Rapid intermittent beep (0.05 sec. sound / 0.05 sec. silent)
	No.7	3600Hz Long intermittent beep (1.5 sec. sound / 1.5 sec. silent)
	No.8	3600Hz Fast intermittent beep (0.5 sec. sound / 0.5 sec. silent)
	No.9	2400Hz & 3375Hz Multiplexed Beep (0.25 sec. / 0.25 sec.)
	No.10	2400Hz & 3600Hz Multiplexed Beep (0.25 sec. / 0.25 sec.)
	No.11	4000Hz & 4800Hz Multiplexed Beep (0.25 sec. / 0.25 sec.)
Volume Control		The set up button is the fourth step (Factory Default: Maximum, Switchable by Web setup tool) [Maximum] -> [-5dB drop from maximum (standard)] -> [-10dB drop from maximum (standard)] -> [OFF] (-> Returns to [Maximum]), Switchable by Web setup tool
※ 1 Environmental Condition: All tiers lighting Amber, buzzer sounding Buzzer No.1 at maximum volume.		
※ 2 Environmental Condition: Tier 1 lighting Amber with no sound.		

Model		LA6-5DSNWB-POE
Luminous Intensity (typ) ※ 3		Red (1000mcd), Amber (1700mcd), Green (2600mcd), Blue (1000mcd), White (1250mcd) Purple (800mcd), Pink (850mcd), Lemon (2150mcd), Sky blue (2150mcd)"
Flashing Rate		"30±2 Flashes Per Minute, 60±2 Flashes Per Minute, 120±2 Flashes Per Minute (Factory Default: 60 Flashes Per Minute) Switchable by Web setup tool"
Interface	Power/Contact Input	Screwless Terminal Block (Number of Contacts: 12) Wire Diameter: 0.2 - 1.5mm ² (Solid Wire), AWG24-16 (Stranded Wire) "Power: 2(DC24V) Contact Input: (External relay/NPN/PNP): 8 Flashing/Pulse Enable: 1 COM: 1"
		LAN
	PoE	Corresponding to IEEE802.3af Class 0 Conformity
	Communication Method	Ethernet (IEEE802.3 Conformity)
	Physical Layer	10BASE-T/100BASE-TX (Auto-MDI/MDIX)
	Data Link Layer	CSMA/CD
	Network Layer	IP/ARP/ICMP
	Transport Layer	TCP/UDP
	Application Layer	HTTP/HTTPS/DHCP/Modbus TCP/Socket (Corresponds to PHN/PNS Commands)
	USB	USB micro-B Terminal USB2.0
Operation Part		Multi-function Button (Set in Head Cover) Clear Switch
Indicator Light		1 (Green): Built in Clear Switch ※ Always ON when Power is applied
Various Settings		Switchable by Web setup tool
Operational Method		Signal Wire Control/Command Control
Accessory		Rubber Sheet
Optional Parts		Wallmount Bracket (NH-WST2)
Connectable LAN cable		Category 5e or higher (Both Straight Cable and Cross Cable can be used)
Conformity Standards		RoHS Directive (EN 50581) EMC Directive (EN 61000-6-4, EN 61000-6-2, EN55032 ClassA, EN55024) FCC Part 15 Subpart B Class A, ICES-003 Class A KC (KN 61000-6-4, KN 61000-6-2) UL 508, CSA-C22.2 No.14 Recognized Component (File No.E215660) ※ DC24V supply only UL 60950-1, CAN/CSA C22.2 No. UL60950-1-07 Recognized Component (File No.E480103)
Remarks		CE Marking
※ 3 Due to the characteristics of the LED elements, a variation in difference of the color tone and brightness of every product may occur."		

■ Correspondance tabelle of RGB color model

Color Number		Image	RGB color model
1	red		#FF0000
2			#FF3300
3			#FF6600
4			#FFAA00
5	yellow		#FFCC00
6			#FFEE00
7	lemon		#EEFF00
8			#CCFF00
9	green		#00FF00
10			#00FF66
11	skyblue		#00BBDD
12			#0099EE
13	blue		#0033FF
14			#6699EE
15			#9966EE
16	purple		#CC00DD
17	pink		#FF00CC
18			#FF0099
19			#FF0066
20			#FF0033
21	white		#FFFFFF
22	(Off)	-	#000000

PATLITE Corporation G2J	
PATLITE Corporation ※Head office	■ www.patlite.com/
PATLITE (U.S.A.) Corporation	■ www.patlite.com/
PATLITE Europe GmbH ※Germany	■ www.patlite.eu/
PATLITE (SINGAPORE) PTE LTD	■ www.patlite-ap.com/
PATLITE (CHINA) Corporation	■ www.patlite.cn/
PATLITE KOREA CO., LTD.	■ www.patlite.co.kr/
PATLITE TAIWAN CO., LTD.	■ www.patlite.tw/
PATLITE (THAILAND) CO., LTD.	■ www.patlite.co.th/
PATLITE MEXICO S.A. de C.V.	■ www.patlite.com.mx/

- Specifications may change without notice due to continual product improvement.
- PATLITE and the PATLITE logo is a trademark, or registered trademark of the PATLITE Corporation of Japan and each country.
- Windows is a registered trademark of the U.S. Microsoft Corporation in the U.S. and other countries.