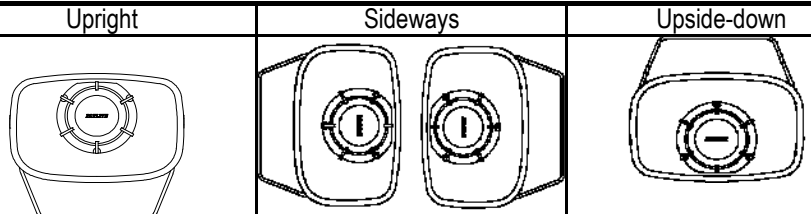
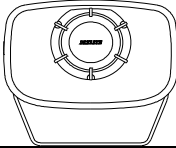
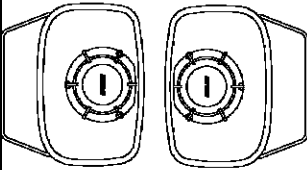
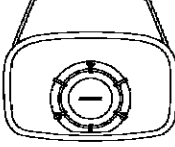

SPECIFICATIONS

1. Specifications

1-1. General Specification

Model		EHV-M1		
Rated Voltage		DC12 V-DC24 V		
Operating Voltage Range		DC10.8 V-DC35 V		
Rated Current Consumption	Max.	480 mA		
	Typ.	4.0 W (at DC12 V)		
Rated Power Consumption (for NPN/No-voltage)	Conditions	Volume at maximum and a 1 kHz at -6 dB sinusoidal wave played back		
	Max.	5.8 W (at DC12 V)		
	Conditions	At maximum volume and "Rapid Hi-Lo" alarm playback		
	Typ.	5.0 W (at DC12 V)		
Rated Power Consumption (for PNP/Voltage Input)	Conditions	Volume at maximum and a 1 kHz at -6 dB sinusoidal wave played back		
	Max.	8.0 W (at DC31.6 V)		
	Conditions	At maximum volume and "Rapid Hi-Lo" alarm playback		
	Typ.	5.0 W (at DC12 V)		
Inrush Current	4 A or less (at DC12 V)			
	9 A or less (at DC24 V)			
	12.5 A or less (at DC35 V)			
Operating Ambient Temperature		-20 °C to +50 °C		
Operating Ambient Humidity		Less than 85 % (No condensation)		
Storage Ambient Temperature		-30 °C to +60 °C		
Storage Ambient Humidity		Less than 85 % (No condensation)		
Mounting Location		Indoors/Outdoors		
Mounting Direction	Upright	Sideways		Upside-down
				
Protection Rating		IP65 (IEC 60529)		
Environmental Condition		Upright Installation		
Insulation Resistance		More than 1 MΩ at 500 VDC between the terminals and the chassis		
Withstand Voltage		500 VAC applied for 1 min between terminals and chassis without breaking insulation		
Vibration Resistance		45.0 m/s ² IEC 60068-2-6:2007 (Upright Position)		
Impact Resistance		250 m/s ² 6 ms for 1,000 times (3 axis 1 direction); 500 m/s ² 11 ms for 3 times (3 axis both directions) IEC 60068-2-27:2008 (Upright Position)		
Mass (Tolerance: ±10%)		1.25 kg		
Sound Pressure Level (Alarm)		Maximum: 110 dB		
Environmental Conditions		Upright position from horn opening at a distance of 1 m. Volume at maximum and "Stutter" alarm played.		
Sound Pressure level (MP3)		Maximum: 105 dB		
Environmental Conditions		Volume at maximum and a 1 kHz at -6 dB sinusoidal wave played back from the horn opening.		
Outer Dimensions		Refer to 6. Outer Dimension Drawing		
Conformity Standards		EMC Directive (EN 61000-6-4, EN 61000-6-2) RoHS Directive (EN 50581) UL 464, CSA-C22.2 No. 205-M1983 FCC Part15 SubpartB Class A KC (KN22, KN24)		
Remarks		UL Listed (File No.S24210)		
No.EHV-W18F-1 18				
PATLITE Corporation				

Model		EHV-M2		
Rated Voltage		AC100 V-AC240 V (50/60 Hz)		
Operating Voltage Range		AC90 V-AC264 V (50/60 Hz)		
Rated Current Consumption	Max.	150 mA		
Rated Power Consumption (for NPN/No-voltage)	Typ.	5.3 W (at AC240 V)		
	Conditions	Volume at maximum and a 1 kHz at -6 dB sinusoidal wave played back		
	Max.	7.9 W (at AC264 V)		
	Conditions	At maximum volume and "Rapid Hi-Lo" alarm playback		
Inrush Current		6 A or less (at AC100 V)		
		15 A or less (at AC240 V)		
		23 A or less (at AC264 V)		
Operating Ambient Temperature		-20 °C to +50 °C		
Operating Ambient Humidity		Less than 85 % (No condensation)		
Storage Ambient Temperature		-30 °C to +60 °C		
Storage Ambient Humidity		Less than 85 % (No condensation)		
Mounting Location		Indoors/Outdoors		
Mounting Direction	Upright	Sideways		Upside-down
				
Protection Rating		IP65 (IEC 60529)		
Environmental Condition		Upright Installation		
Insulation Resistance		More than 1 MΩ at 500 VDC between the terminals and the chassis		
Withstand Voltage		1500 VAC applied for 1 min between terminals and chassis without breaking insulation		
Vibration Resistance		45.0 m/s ² IEC 60068-2-6:2007 (Upright Position)		
Impact Resistance		250 m/s ² 6 ms for 1,000 times (3 axis 1 direction); 500 m/s ² 11 ms for 3 times (3 axis both directions) IEC 60068-2-27:2008 (Upright Position)		
Mass (Tolerance: ±10%)		1.25 kg		
Sound Pressure Level (Alarm)		Maximum: 110 dB		
Environmental Conditions		Upright position from horn opening at a distance of 1 m. Volume at maximum and "Stutter" alarm played.		
Sound Pressure level (MP3)		Maximum: 105 dB		
Environmental Conditions		Volume at maximum and a 1 kHz at -6 dB sinusoidal wave played back from the horn opening.		
Outer Dimensions		Refer to 6. Outer Dimension Drawing		
Compliance Standards		UL 464, CSA-C22.2 No. 205-M1983 FCC Part15 Subpart B Class A KC (KN22, KN24)		
Remarks		UL Listed (File No.S24210) There are no contents of controlled substances exceeding the threshold for the RoHS Directive.		
No.EHV-W18F-2 18				

PATLITE Corporation

1-2. Performance Specifications

MP3 Mode Switch Condition	MP3 setting ON	MP3 setting OFF
Volume Control	Volume Adjustable: Min. - Max.	
	Sound Reduction Input: It is a value specified as a reduction from the currently adjusted volume. (None, -10 dB, -20 dB, -30 dB selection)	-
Sound Playback	MP3 data / Alarm/Melody (Standard)	Alarm/Melody (Standard)
Number of Playback Channels	Bit Input: 8/binary input: 63	
Alarm/Melody	7. Sound List Reference	
Playback Mode	normal playback / input priority playback / hold playback / memory playback	
	Mode Switch (DIPSW) Selection Possible.	Hold Playback
Playback start-up time	300 ms or less (Signal Input and Power Supply Startup)	

1-3. MP3 Data Specification

Playback File	MPEG1-Audio Layer III (MP3, Fs:44.1kHz)
Bit Rate	32 Kbit/s, 64 Kbit/s (Standard), 128 Kbit/s Constant Bit Rate (CBR)
Maximum Playback Time	A total of 220 seconds (calculated with one MP3 file at the standard bit rate)
Internal Memory Size	2 MByte (Management Territory is Included)
Supported Memory Card	SD Card/SDHC Card
	Recommended Parts: SDV-2GP (option)
SD Card Format	FAT 16, 32
Supported Application Software	PATLITE Playlist Editor 2
	(MP3 data rewriting, alarm/melody selection)
Remarks	MPEG Layer-3 audio coding technology licensed from Fraunhofer IIS and Thomson Licensing.

1-4. Signal Input Specification

Signal Input Priority	Channel 8 > Channel 7 > Channel 6 > Channel 5 > Channel 4 > Channel 3 > Channel 2 > Channel 1 (except for a binary input)	
Contact Control Method	[EHV-M1]: Non-voltage/Voltage Contact [EHV-M2]: Non-voltage Contact	
Contact Closed-Circuit Current	12mA or less	
Contact Open-Circuit Voltage	[EHV-M1]: 6V or less [EHV-M2]: 8V or less	
Contact Input (Circuit Configuration)	<p>Non-voltage Contact</p>	<p>Voltage Contact (EHV-M1 Only)</p>
	Transistor Input (Circuit Configuration)	<p>NPN Transistor</p>
No.EHV-W18F-3_18		

2. Model

EHV - M1 H F M

Rated Voltage

M1 DC12 V-DC 24V
M2 AC100 V-AC 240V

Wiring Specifications

H Cable
T Terminal Buss

Melody Type

F Type F
G Type G

Message Recording

Blank None
M Factory Installed Messages

3. Wiring Diagram

- Non Voltage Contact

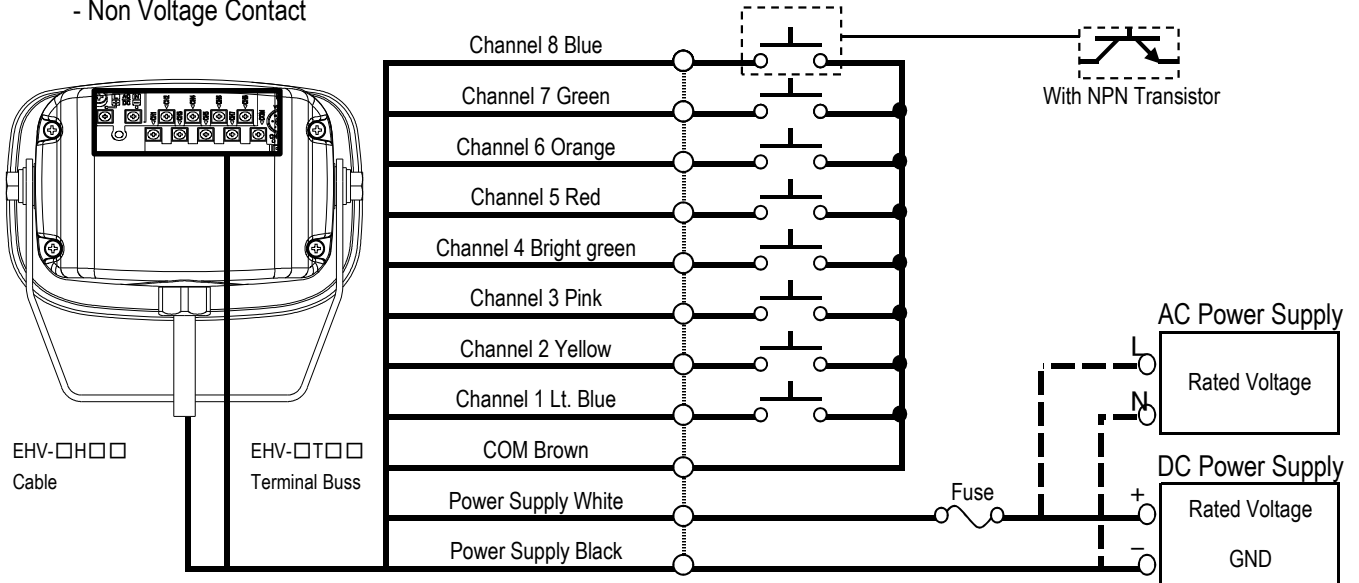

- Voltage Contact (EHV-M1 Only)

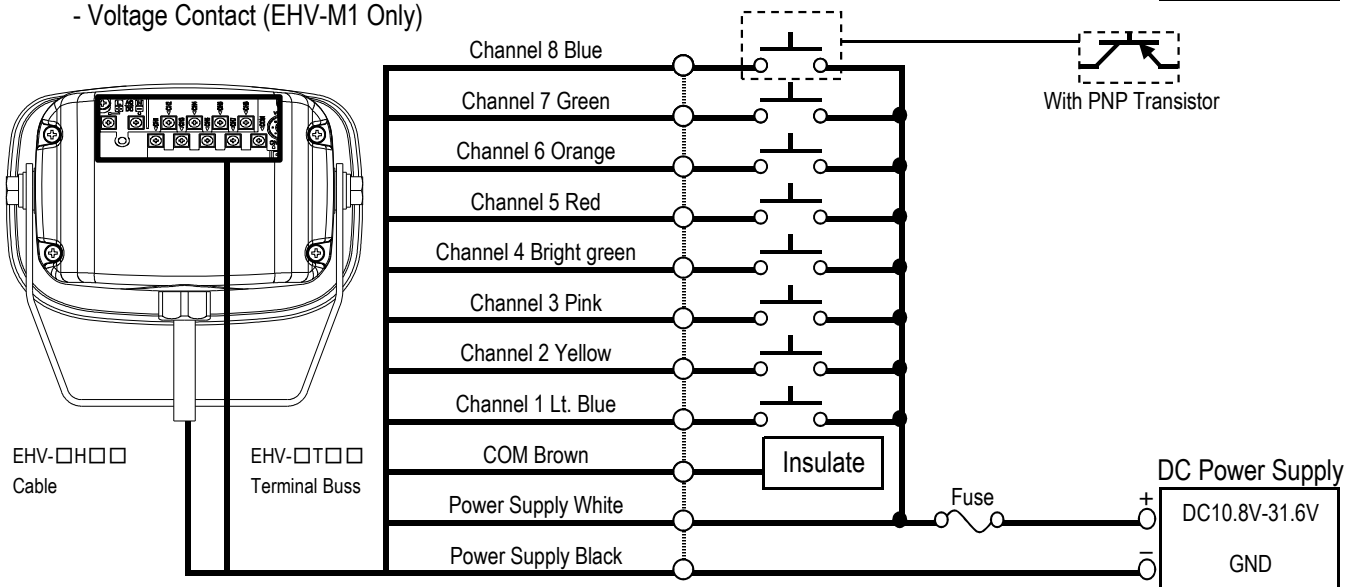

- * Each channel color is indicated by the cable or lead wire.
- * Voltage contact input should be in the range of DC10.8 V to DC31.6 V.
- * When using the Terminal type model, round terminals with M3 insulated coating is recommended when wiring to the Terminal.
Recommended Parts: J.S.T. Manufacturing Co., Ltd. N1.25-3 (article corresponding to RoHS)

When connecting a Source-type PLC, be sure to insert a diode as indicated in the drawing below. Failure to insert a diode will lead to possible malfunction.

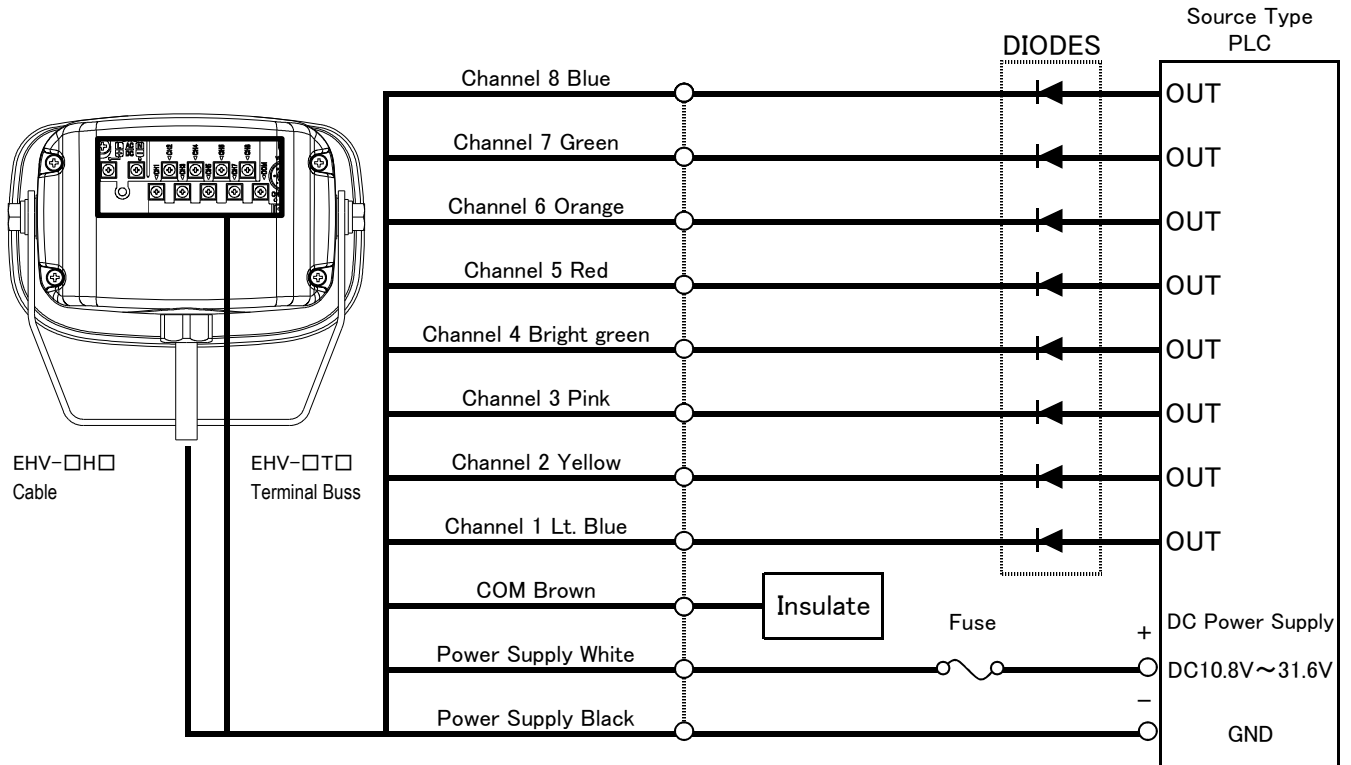

※Select a diode with ratings indicated below.

Forward Current	50mA or more
Reverse Voltage	50V or more

4. Part Names and Functions

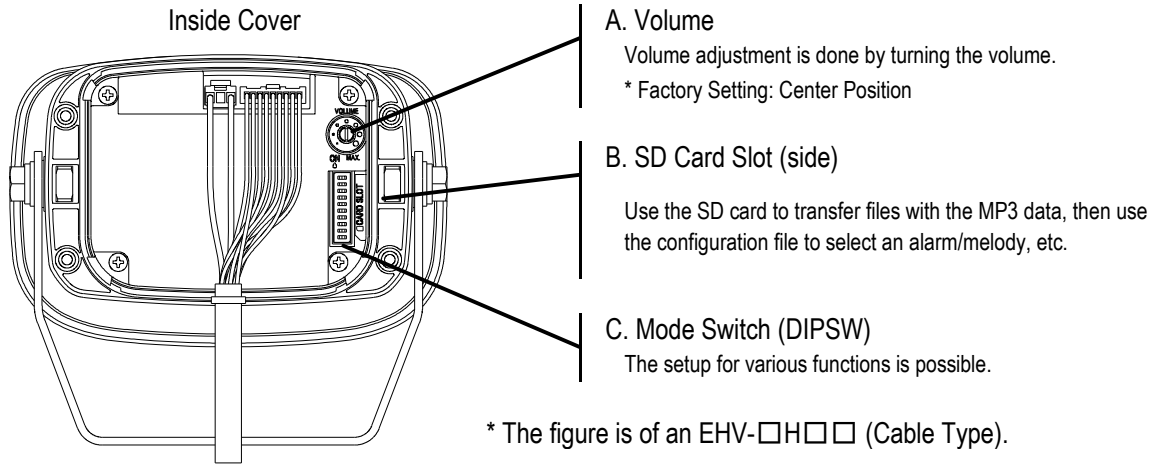

Mode Switch Function Assignment

Mode Switch	(6) Forced Playback OFF	(6) Forced Playback ON
(5) MP3 Setup OFF		
(5) MP3 Setup ON		

Mode Switch Function List

Function Name	Setting Index	Details
(1) Sound Group	Groups A-P	Refer to "5-1. Sound Group."
(2) Channel Input Method	Binary/Bit	Refer to "5-2. Channel Input Method."
(3) Playback Mode	Normal playback / Input priority playback / Hold playback / Memory playback	Refer to "5-3. Playback Mode."
(4) Sound Mode	Factory Mode / Public Address Mode	Refer to "5-4. Sound Mode."
(5) MP3 Setup	MP3 Setup ON/OFF	Refer to "5-5. MP3 Setup."
(6) Forced Playback	Forced Playback ON/OFF	Refer to "5-9. Forced Playback."
(7) Tone Selection	Playback Sound Selection	

5. Functionality Details

5-1. Sound Group

When "(5) MP3 setup" switch is being turned OFF, the sound group can be selected from up to 16 variations from groups A-P with the Mode Switch (DIPSW).

A sound group cannot be selected when "(2) channel input method" is set for binary.

Refer to "7. sound list" for the Mode Switch (DIPSW) and sound group combination which can be selected.

* Factory Setting: Group A

5-2. Channel Input Method

Channel input mode can be selected for bit/binary with the Mode Switch (DIPSW).

With the bit input, channels 1-8 can be used to reproduce up to eight channels.

With the binary input, channels 1-6 can be used to reproduce up to 63 channels.

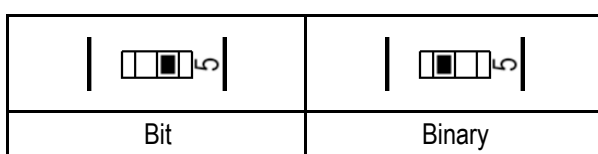

* Factory Setting : EHV-□□□ ... Bit
 EHV-□□□M ... Specified Messages less than 8: Bit
 Specified Messages greater than 9: Binary

Binary Input Table

Sound No.	Channel								Sound No.	Channel							
	1	2	3	4	5	6	7	8		1	2	3	4	5	6	7	8
1	0								33	0					0		
2		0							34		0				0		
3	0	0							35	0	0				0		
4			0						36			0			0		
5	0		0						37	0		0			0		
6		0	0						38		0	0			0		
7	0	0	0						39	0	0	0			0		
8				0					40				0		0		
9	0			0					41	0			0		0		
10		0		0					42		0		0		0		
11	0	0		0					43	0	0		0		0		
12			0	0					44			0	0		0		
13	0		0	0					45	0		0	0		0		
14		0	0	0					46		0	0	0		0		
15	0	0	0	0					47	0	0	0	0		0		
16					0				48					0	0		
17	0				0				49	0				0	0		
18		0			0				50		0			0	0		
19	0	0			0				51	0	0			0	0		
20			0		0				52			0		0	0		
21	0		0		0				53	0		0		0	0		
22		0	0		0				54		0	0		0	0		
23	0	0	0		0				55	0	0	0		0	0		
24				0	0				56				0	0	0		
25	0			0	0				57	0			0	0	0		
26		0		0	0				58		0		0	0	0		
27	0	0		0	0				59	0	0		0	0	0		
28			0	0	0				60			0	0	0	0		
29	0		0	0	0				61	0		0	0	0	0		
30		0	0	0	0				62		0	0	0	0	0		
31	0	0	0	0	0				63	0	0	0	0	0	0		
32						0											

0 -- Switch ON

5-3. Playback Mode

The Mode Switch (DIPSW) can select from four different kinds of playback modes.
 When "(5) MP3 setup" is OFF, the hold playback function is active, regardless of the Mode Switch position.

Normal Playback	Input Priority Playback	Hold Playback	Memory Playback

* Factory Setting : Normal Playback

- Normal Playback

If a signal input (Playback) is a pulse input, playback is ended as soon as the pulse input is off.
 The signal input (Playback) is maintained only when the input is held on.
 The signal input (Playback) becomes invalid during playback.

- Channel Input Method : Bit Input

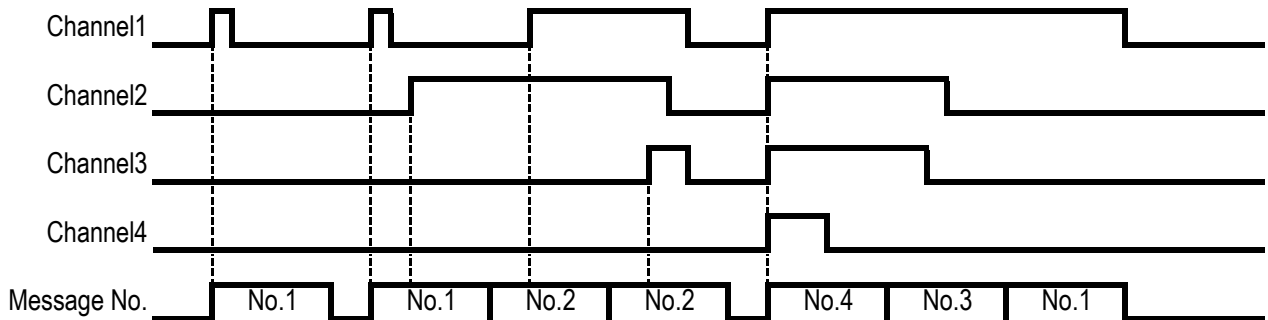

* All channels above 5 are the same

- Channel Input Method : Binary Input

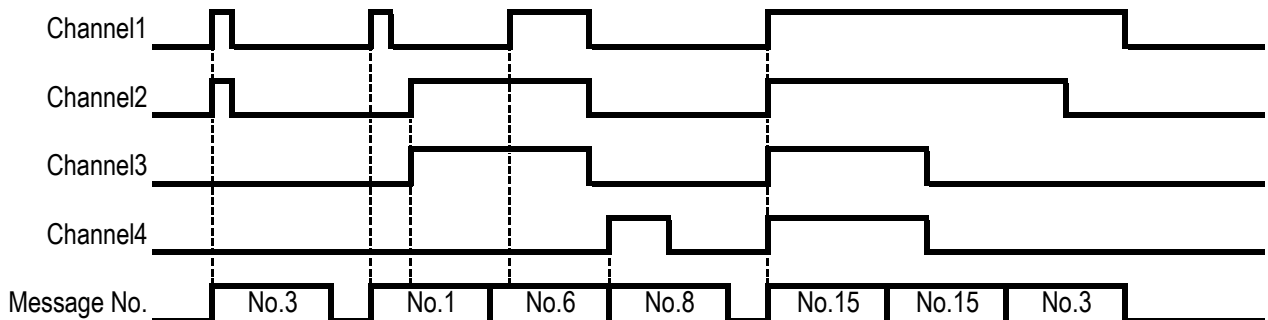

* All channels above 5 are the same

- During a Stop / Clear Input

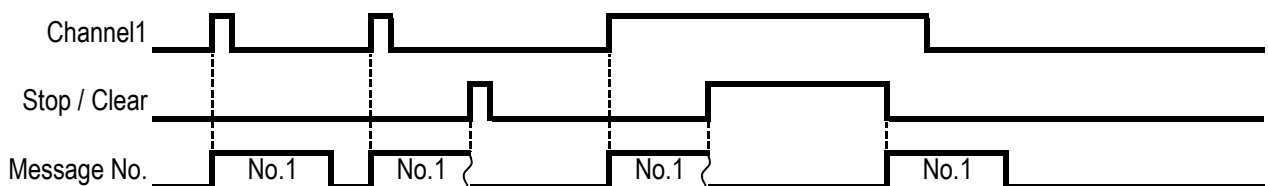

* The way line indicates when playback is stopped.

- Input Priority Playback

When a signal input (Playback) is on during playback, the playback is stopped and the channel from the signal input (Playback) is reproduced.

If the signal input (Playback) is a pulse input, even with the input held, playback plays only once.

- Channel Input Method : Bit Input

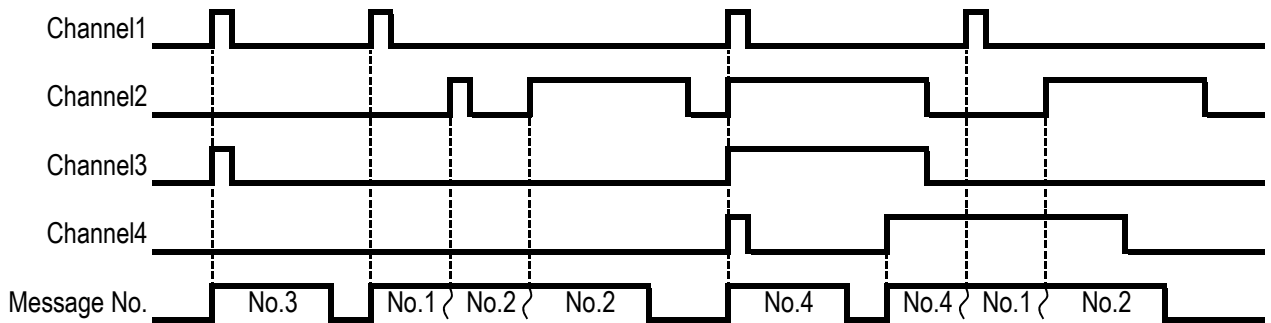

* All channels above 5 are the same

* The wavy line indicates when playback was stopped and the message No. which was the priority signal input (Playback) is played.

- Channel Input Method : Binary Input

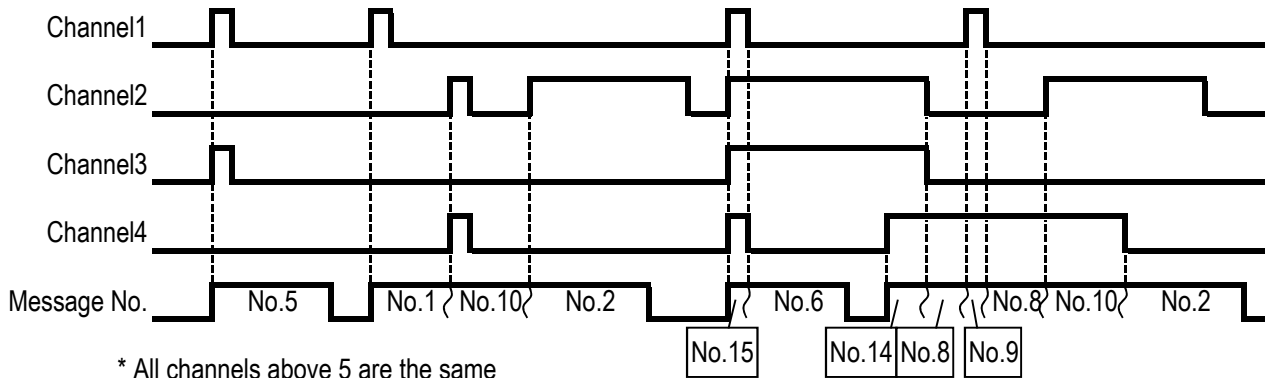

* All channels above 5 are the same

* The wavy line indicates when playback was stopped and the message No. which was the priority signal input (Playback) is played.

- During a Stop / Clear Input

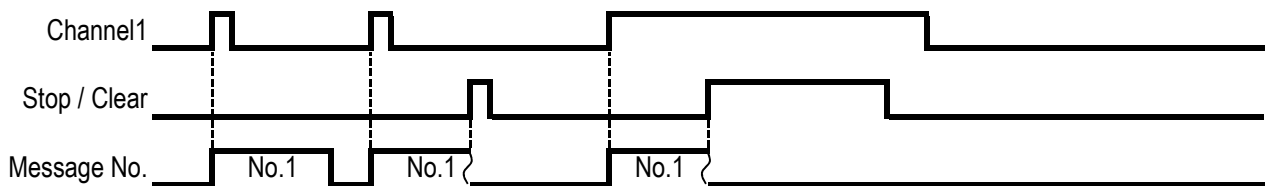

* The wavy line indicates when playback is stopped.

- Hold Playback

It only plays back while the signal input (Playback) is maintained.
 Playback is stopped when the signal input (Playback) is removed.
 Repeated playback is done by maintaining a signal input (Playback).
 It does not play back if a signal input (Playback) is a pulse input.

- Channel Input Method : Bit Input

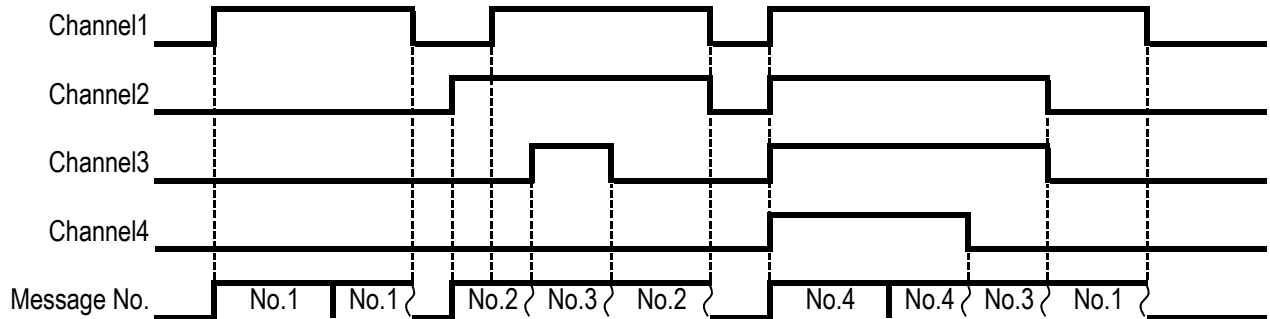

* All channels above 5 are the same
 * The wavy line indicates when playback was stopped and the message No. which was the changed signal input (Playback) is played.

- Channel Input Method : Binary Input

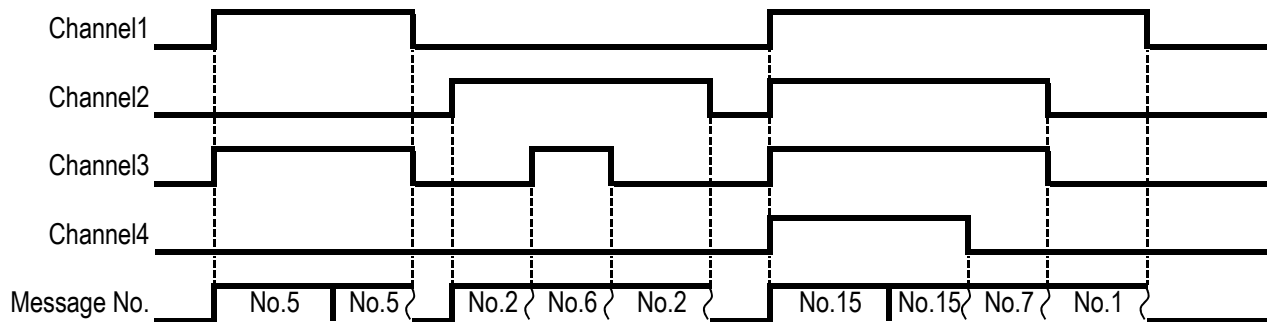

* All channels above 5 are the same
 * The wavy line indicates when playback was stopped and the message No. which was the changed signal input (Playback) is played.

- During a Stop / Clear Input

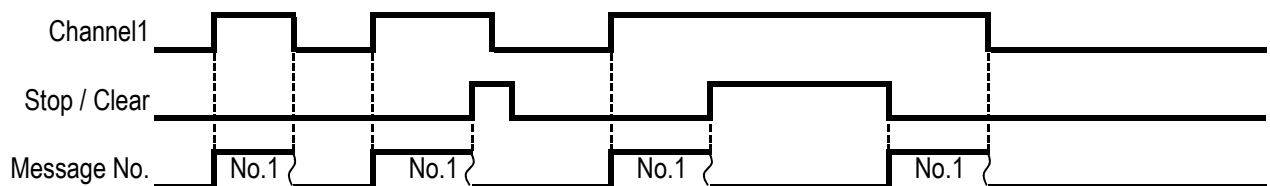

* The wavy line indicates when playback is stopped.

- Memory Playback

When several signal inputs (Playback) are entered during playback, the memory of up to 5 signal inputs will play the corresponding message No.

Signal inputs beyond the memory capacity is ignored.

When playback is ended, the next available channel stored in memory will play.

If the signal input (Playback) is a pulse input, even with the input held, the next message in memory is played back only once.

- Channel Input Method : Bit Input

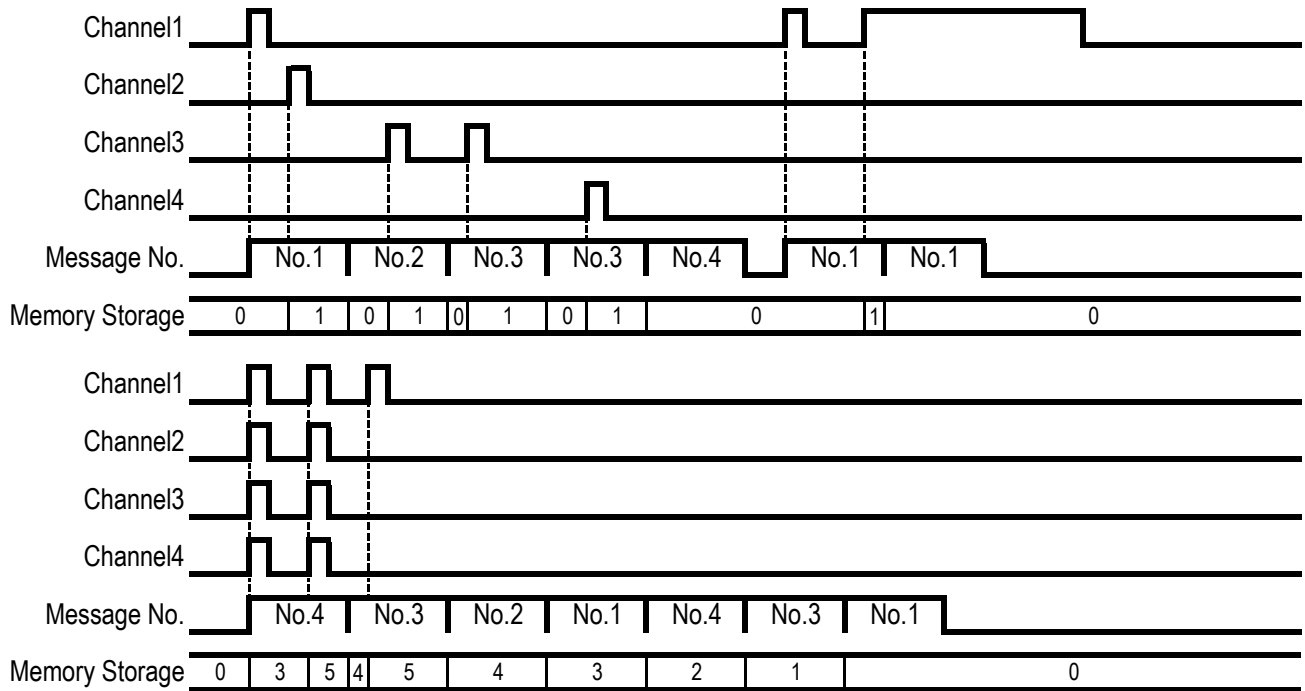

* All channels above 5 are the same

- Channel Input Method : Binary Input

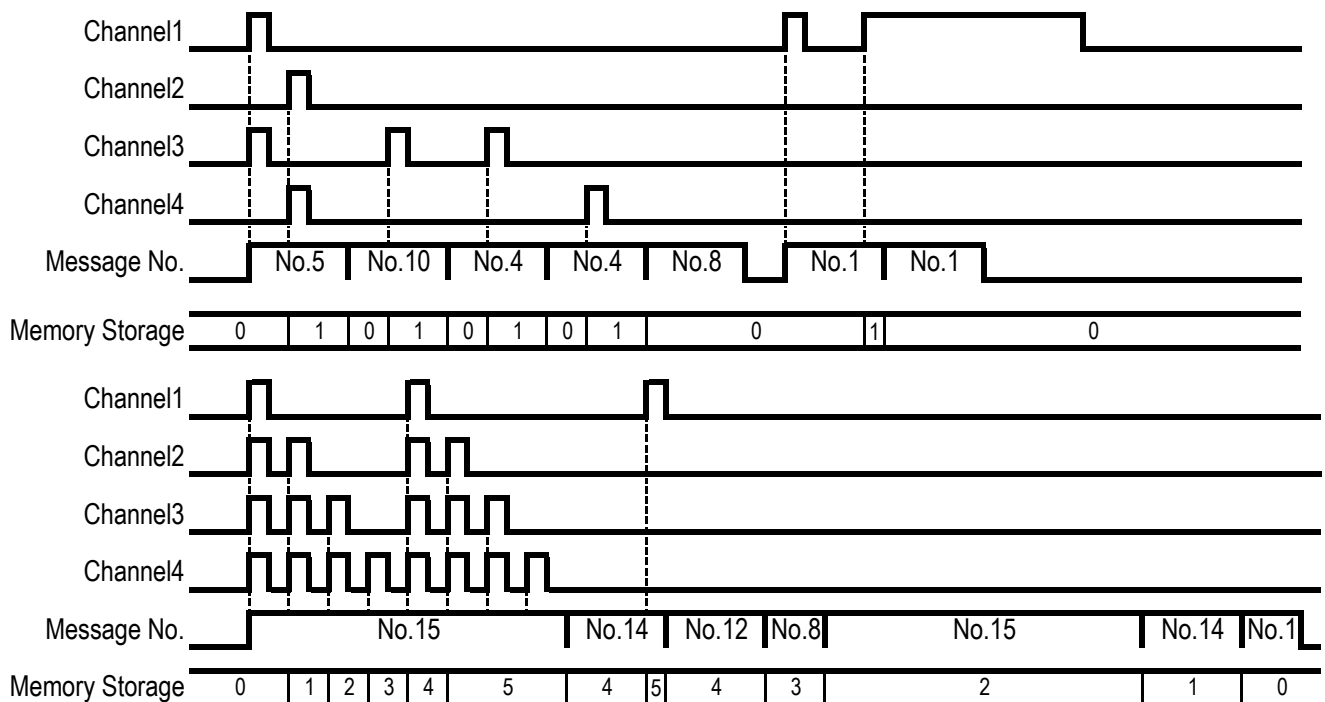

* All channels above 5 are the same

- During a Stop input

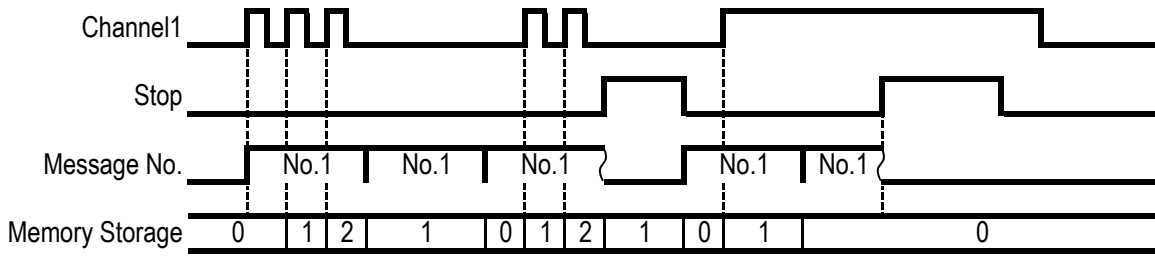

* The wavy line indicates when playback is stopped.

- During a Clear input

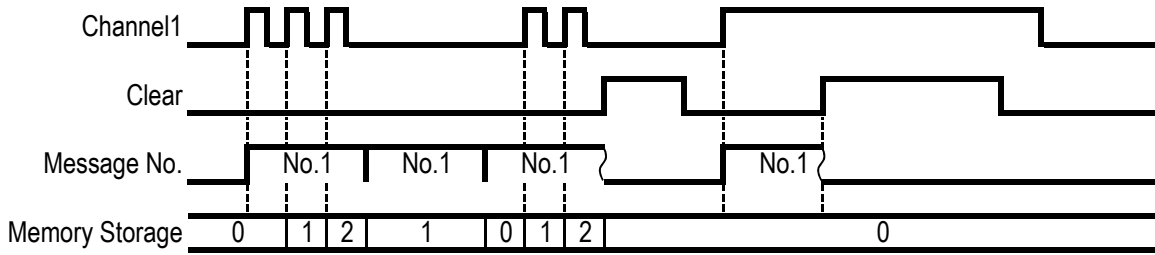

* The wavy line indicates when playback is stopped.

5-4. Sound Mode

The alarm/melody audibility reproduction can be selected with the Mode Switch (DIPSW).

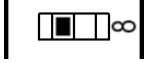

	
"Factory Mode"	"Public Address Mode"

- Factory Mode -- The audible sound is suitable as a warning alarm.
- PA Mode -- The audible sound is suitable for public announcements.

* Factory Setting: "Factory Mode"

5-5. MP3 Setup

The MP3 can be selected for ON/OFF with the Mode Switch (DIPSW).

	
MP3 setting OFF	MP3 setting ON

- MP3 setup ON ... MP3 data + Alarm/Melody
 - MP3 data and alarm/melody data can be freely combined.
 - MP3 data can be freely written, using an SD card.
 - An alarm/melody can be selected from the built-in sounds.
 - Registration of MP3 data, and a select and registration of an alarm melody are exclusive software (PATLITE Playlist Editor 2).
It carries out by using it.
 - Playback modes can be selected.
- MP3 setup OFF ... Alarm/Melody
 - The alarm/melody can be selected among the built-in sounds.
 - The 63 sounds are divided and registered into 16 kind of groups.
 - A sound group is selected with the Mode Switch (DIPSW).
 - The Playback mode is made into the hold playback mode.

* Factory Setting : EHV-□□□ ... MP3 setup OFF
 EHV-□□□M ... MP3 setup ON

5-6. MP3 Data Rewriting

With the optional SD Card, MP3 data can be freely rewritten.

Rewriting MP3 data requires the use of dedicated software (PATLITE Playlist Editor 2) and designating a regular file name.

The built-in alarm/melodysounds are not overwritten.

Item	When the dedicated software (PATLITE Playlist Editor 2) is used	When the dedicated software (PATLITE Playlist Editor 2) is not used
Playback message No. The number of MP3 data per one	A maximum of 16 data files (It is combined freely and can playback in order)	One piece of data
Individual MP3 data settings are made	When setting up sound volume, end of playback blank-time, and Repeat Playback.	Cannot set up manually.
Channel Assignment Function	When setting up to choose "playback", "sound reduction", "stop", and "clear".	All are assigned for "playback".

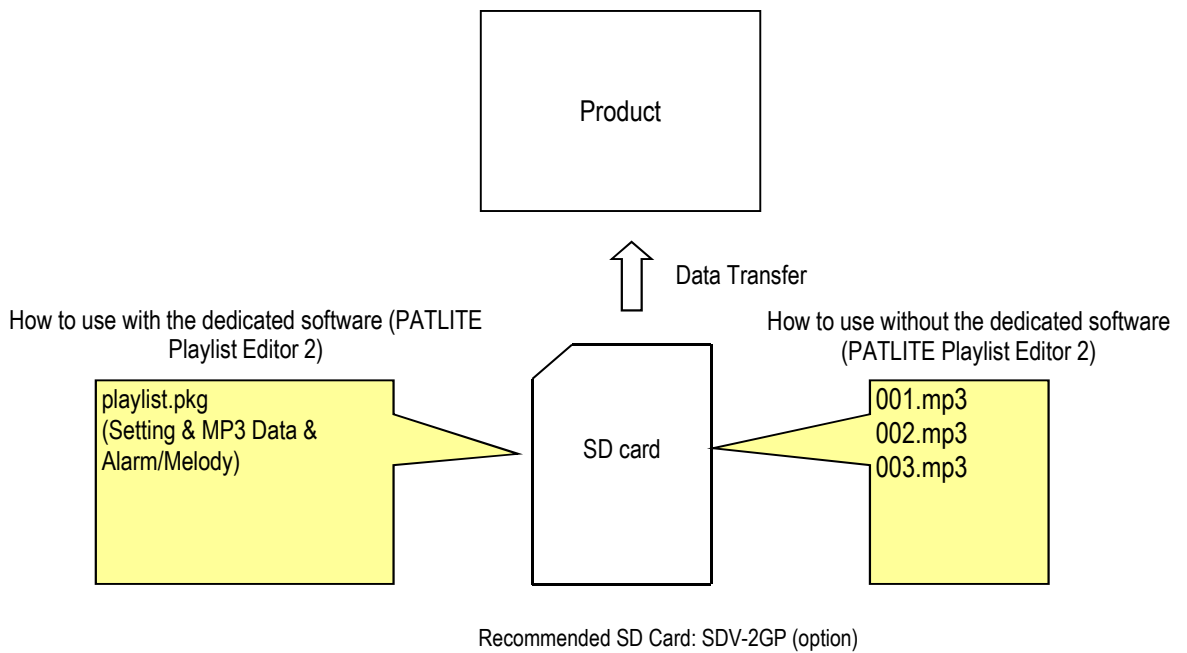

5-7. Channel function (Function Which Uses Exclusive Soft "PATLITE Playlist Editor 2")

Dedicated software (PATLITE Playlist Editor 2) can be used to assign functions to each signal input. In order for the channel function assignments to be used, the setup data has to be transmitted to the product via the SD Card.

If the MP3 setup mode is OFF, this function becomes invalid.

- Playback
The corresponding channels are played back.
- Sound Reduction
The volume of sound being played back is decreased.
A maximum of two sound reduction channels can be assigned.
When two sound reduction values are set up, three sound reduction levels can be made.
- Stop
The channel during playback is stopped.
In the Memory Playback Mode, playback is stopped and the next channel in memory is played next.
A playback input is ignored during a STOP input.

- Clear
In the memory playback mode, all channels in memory is erased when an input occurs.
In other playback modes outside memory playback, the same operation as the stop function occurs.
If simultaneous inputs for CLR and STOP occurs, priority is given to the CLR input.
When channels are assigned for sound reduction, STOP, and CLR, the available number of playback channels decrease.

Example: For a maximum number of bit inputs;

- channel1 - channel5 => playback
- channel6 => sound reduction
- channel7 => stop
- channel8 => clearance

In this case, the available number of playback channels is set to five.

* Factory Setting : channels 1-8 are all set as "Playback".

5-8. Sound Reduction

- (6) When Forced Playback is OFF (the function which uses exclusive soft "PATLITE Playlist Editor 2")
Using the dedicated software (PATLITE Playlist Editor 2), If a signal input is assigned with the sound reduction function, the sound level of the message being played back will be reduced.
(Refer to "5-7. Channel Assignment Function")
The input state for sound reduction 1 and sound reduction 2 can be set up for three steps in sound reduction. (-10dB, -20dB, -30dB)

In order for the sound reduction function to be used, the setup data to assign the channel has to be transmitted to the product via an SD card.

Sound Reduction 1	With no input	With an input	With no input	With an input
Sound Reduction 2	With no input	With no input	With an input	With an input
Sound Reduction Level	No Sound Reduction	-10dB	-20dB	-30dB

* Factory Setting: Sound Reduction Function OFF

- (6) Forced Playback ON
With a Forced Playback, if a signal line input occurs, the playback sound can be reduced.
The sound reduction level can be selected by the channel input.
Priority rank is channel3>channel2>channel1.

Signal Input Condition	Sound Reduction Volume
None	No Sound Reduction
Channel1	-10dB
Channel2	-20dB
Channel3	-30dB

5-9. Forced Playback

When the Forced Playback mode is turned ON, it will play back after power is supplied, even with no signal input. It can be used for testing the playback volume or when controlled by power supply start-up. The Forced Playback is selected for ON/OFF with the Mode Switch (DIPSW). The sound (channel) to play back can be selected by the Mode Switch (DIPSW).

MP3 setting ON : MP3 data and alarm/melody is selected with Mode Switch Numbers 1 - 6.

MP3 setting OFF : Built-in Sounds are selected with Mode Switch Numbers 1 - 6.



* Factory Setting: Forced Playback OFF

Sound Select Diagram

Sound No.	Mode Switch						Sound No.	Mode Switch						
	1	2	3	4	5	6		1	2	3	4	5	6	
1							33							0
2	0						34	0						0
3		0					35		0					0
4	0	0					36	0	0					0
5			0				37			0				0
6	0		0				38	0		0				0
7		0	0				39		0	0				0
8	0	0	0				40	0	0	0				0
9				0			41				0			0
10	0			0			42	0			0			0
11		0		0			43		0		0			0
12	0	0		0			44	0	0		0			0
13			0	0			45			0	0			0
14	0		0	0			46	0		0	0			0
15		0	0	0			47		0	0	0			0
16	0	0	0	0			48	0	0	0	0			0
17					0		49					0	0	
18	0				0		50	0				0	0	
19		0			0		51		0			0	0	
20	0	0			0		52	0	0			0	0	
21			0		0		53			0		0	0	
22	0		0		0		54	0		0		0	0	
23		0	0		0		55		0	0		0	0	
24	0	0	0		0		56	0	0	0		0	0	
25				0	0		57				0	0	0	
26	0			0	0		58	0			0	0	0	
27		0		0	0		59		0		0	0	0	
28	0	0		0	0		60	0	0		0	0	0	
29			0	0	0		61			0	0	0	0	
30	0		0	0	0		62	0		0	0	0	0	
31		0	0	0	0		63		0	0	0	0	0	
32	0	0	0	0	0									

0 -- Switch ON

6. Outer Dimension Drawing

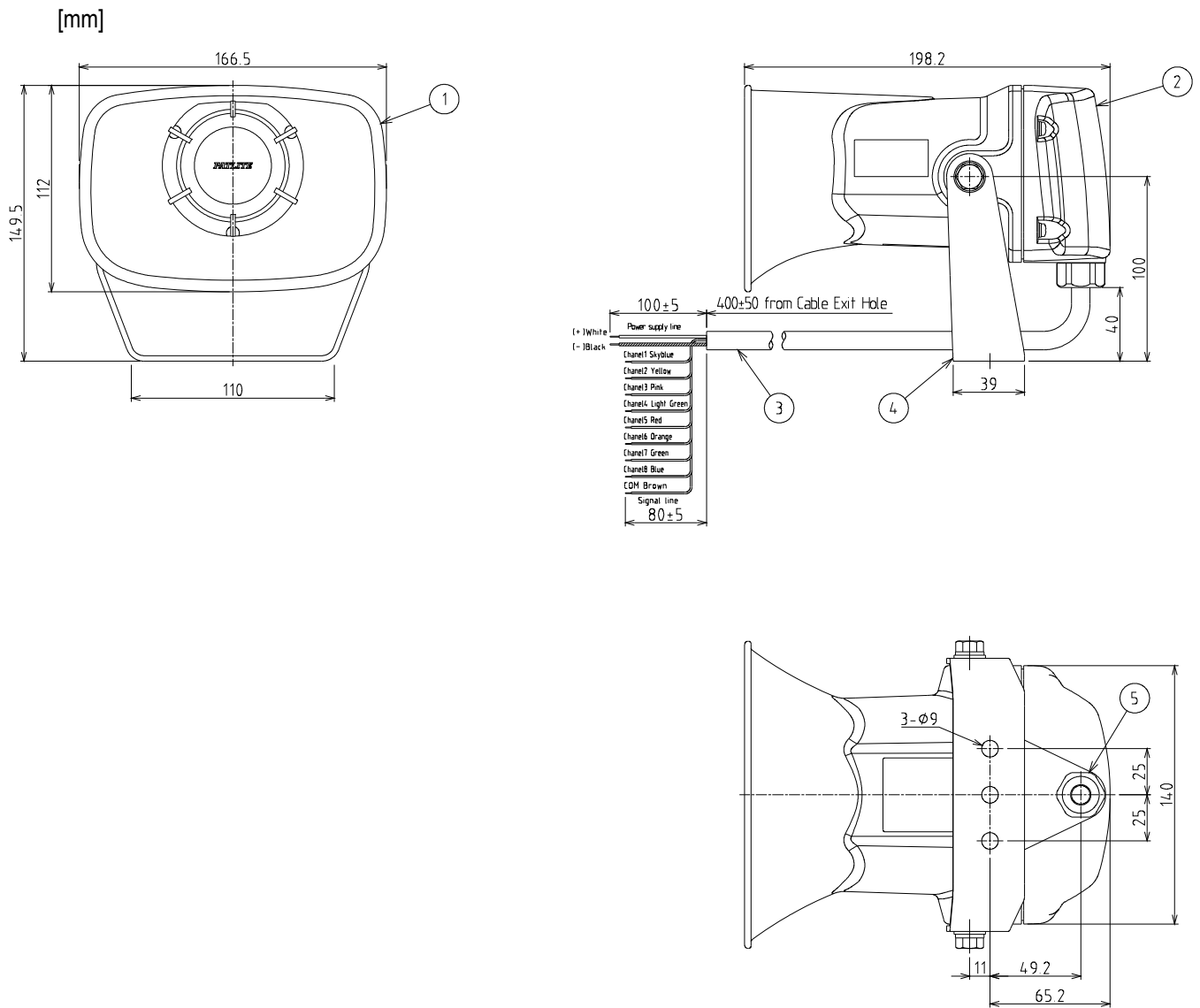

Number	Part Names	Material	Quantity
1	Case	PC	1
2	Cover	PC	1
3	Cable	UL2464 (AWG18x2C+AWG22x9C) ϕ 9	1*
4	Angle Bracket	SUS304 t=3.0	1
5	Waterproof Gland	PA	1









* (3) is attached only to EHV-□H.

7. Sound List

Type F	01	Beep	13	Galactic Hovercraft	25	Ending Notice Chime 2	37	Daydream Believer	49	HATARAKU KURUMA	61	Furusato
	02	Stutter	14	Game Intermission	26	Fur Elise	38	Amaryllis	50	NINGENTTE IINA	62	BEAUTIFUL DREAMER
	03	Bell	15	Spring Melody	27	A Maiden's Prayer	39	Mozart Symphony No.40	51	Robinson	63	JOLLY HOLIDAY
	04	Yelp	16	Jalopy Horn	28	Bach Minuet in Gmjr	40	Quiet Lakeside	52	WORLD FOOTBALL ANTHEM		
	05	Rapid Hi-Lo	17	ET Doorbell	29	Annie Laurie	41	Mountain Musician	53	BANZAI SUKIDE YOKATTA		
	06	Melody Chime	18	RR-crossing	30	London Bridge is falling down	42	Spanish Romance	54	NAMONAKI UTA		
	07	Synthesized Piano	19	Train Whistle	31	Hol-Di-Li-Dia	43	Katyuscha	55	Genesis of Aquarion		
	08	Synthesized Bell	20	Train Ride	32	Mary had a little Lamb	44	Grandfather's Clock	56	Mambo No.5		
	09	Stutter + Bell	21	Starting Notice Chime 1	33	Camptown Races	45	Ave Maria	57	The Parade of the Tin Soldiers		
	10	Synthesized Melody	22	Starting Notice Chime 2	34	Cuckoo	46	RHYTHM AND POLICE	58	Turkey in the Straw		
	11	Chime	23	Starting Notice Chime 3	35	Village Blacksmith	47	ZANKOKUNA TENSHINO TEEZE	59	Aka Tombo		
	12	Call Sign	24	Ending Notice Chime 1	36	On the Avignon Bridge	48	MAJINGAA ZETTO	60	Funiculi, Funicula		









Type G	01	Beep	13	Train Ride	25	Spring Melody	37	Mary had a little Lamb	49	Can-can	61	Nedelka
	02	Stutter	14	Galloping Hi-Lo	26	Jalopy Horn	38	Camptown Races	50	Radetzky March	62	Moonlight Serenade
	03	Bell	15	Alien Chatter	27	ET Doorbell	39	Amaryllis	51	Funiculi, Funicula	63	WAREWA UMINO KO
	04	Yelp	16	Falling Crystals	28	RR-crossing	40	Mozart Symphony No.40	52	Csikos Post		
	05	Rapid Hi-Lo	17	Inverted Reveille	29	Starting Notice Chime 1	41	Ave Maria	53	Polka Trablanka		
	06	Melody Chime	18	Galactic Motor	30	Starting Notice Chime 2	42	Grandfather's Clock	54	O Vreneli		
	07	Synthesized Piano	19	Ring Phone	31	Ending Notice Chime 1	43	The Parade of the Tin Soldiers	55	KAERUNO GASSHOU		
	08	Synthesized Bell	20	Two Tone	32	Ending Notice Chime 2	44	If You're Happy and You Know It	56	El Condor Pasa (If I Could)		
	09	Stutter + Bell	21	Alarm Clock	33	Fur Elise	45	Flea Waltz	57	Hungarian Dance No.5		
	10	Synthesized Melody	22	Ring Hi-Lo	34	Bach Minuet in Gmjr	46	Turkey in the Straw	58	William Tell Overture		
	11	Chime	23	Galactic Hovercraft	35	Annie Laurie	47	The Battle Hymn of the Republic	59	Pomp and Circumstance		
	12	Call Sign	24	Game Intermission	36	London Bridge is falling down	48	J'ai perdu le do de ma clarinette	60	Greensleeves		

Sound Group List

Sound Group	Group A	Group B	Group C	Group D	Group E	Group F	Group G	Group H
Sound Type / Channel								

Type F	Channel1	Fur Elise	Mary had a little Lamb	Amaryllis	Grandfather's Clock	Spanish Romance	Mary had a little Lamb	Beep	RHYTHM AND POLICE
	Channel2	A Maiden's Prayer	Camptown Races	Mozart Symphony No.40	Ave Maria	Camptown Races	Mozart Symphony No.40	Stutter	ZANKOKUNA TENSHINO TEEZE
	Channel3	Bach Minuet in Gmjr	Cuckoo	Quiet Lakeside	Daydream Believer	Bach Minuet in Gmjr	Hol-Di-Li-Dia	Bell	MAJINGAA ZETTO
	Channel4	Annie Laurie	Village Blacksmith	Mountain Musician	London Bridge is falling down	Ave Maria	Daydream Believer	Yelp	HATARAKU KURUMA
	Channel5	London Bridge is falling down	On the Avignon Bridge	Spanish Romance	Bell	Stutter + Bell	Rapid Hi-Lo	Rapid Hi-Lo	NINGENTTE IINA
	Channel6	Hol-Di-Li-Dia	Daydream Believer	Katyuscha	Yelp	Synthesized Melody	Melody Chime	Melody Chime	Robinson
	Channel7	Chime	Chime	Chime	Synthesized Piano	Synthesized Piano	Synthesized Piano	Synthesized Piano	Synthesized Piano
	Channel8	Call Sign	Call Sign	Call Sign	Synthesized Bell	Synthesized Bell	Synthesized Bell	Synthesized Bell	Synthesized Bell

Type G	Channel1	Fur Elise	Bach Minuet in Gmjr	Fur Elise	Alien Chatter	Train Ride	Rapid Hi-Lo	Beep	The Parade of the Tin Soldiers
	Channel2	Bach Minuet in Gmjr	Annie Laurie	London Bridge is falling down	Falling Crystals	Galloping Hi-Lo	Chime	Stutter	If You're Happy and You Know It
	Channel3	Annie Laurie	Amaryllis	Mary had a little Lamb	Inverted Reveille	Inverted Reveille	Stutter	Bell	Flea Waltz
	Channel4	London Bridge is falling down	Mozart Symphony No.40	Camptown Races	Galactic Motor	Galactic Motor	Ring Phone	Yelp	Turkey in the Straw
	Channel5	Mary had a little Lamb	Grandfather's Clock	Amaryllis	Ring Phone	Alarm Clock	Stutter + Bell	Rapid Hi-Lo	The Battle Hymn of the Republic
	Channel6	Camptown Races	Ave Maria	Grandfather's Clock	Two Tone	Ring Hi-Lo	Synthesized Melody	Melody Chime	J'ai perdu le do de ma clarinette
	Channel7	Chime	Chime	Chime	Alarm Clock	Synthesized Piano	Synthesized Piano	Synthesized Piano	Synthesized Piano
	Channel8	Call Sign	Call Sign	Call Sign	Ring Hi-Lo	Synthesized Bell	Synthesized Bell	Synthesized Bell	Synthesized Bell

Sound Group	Group I	Group J	Group K	Group L	Group M	Group N	Group O	Group P
Sound Type / Channel								

Type F	Channel1	WORLD FOOTBALL ANTHEM	Turkey in the Straw	RHYTHM AND POLICE	ZANKOKUNA TENSHINO TEEZE	Galactic Hovercraft	Annie Laurie	Camptown Races	Daydream Believer
	Channel2	BANZAI SUKIDE YOKATTA	Aka Tombo	BANZAI SUKIDE YOKATTA	MAJINGAA ZETTO	Game Intermission	London Bridge is falling down	Cuckoo	Amaryllis
	Channel3	NAMONAKI UTA	Funiculi, Funicula	Mambo No.5	HATARAKU KURUMA	Spring Melody	Hol-Di-Li-Dia	Village Blacksmith	Mozart Symphony No.40
	Channel4	Genesis of Aquarion	Furusato	Galactic Hovercraft	NINGENTTE IINA	Jalopy Horn	Mary had a little Lamb	On the Avignon Bridge	Quiet Lakeside
	Channel5	Mambo No.5	BEAUTIFUL DREAMER	Game Intermission	Genesis of Aquarion	ET Doorbell	BANZAI SUKIDE YOKATTA	WORLD FOOTBALL ANTHEM	Starting Notice Chime 1
	Channel6	The Parade of the Tin Soldiers	JOLLY HOLIDAY	Spring Melody	Aka Tombo	RR-crossing	NAMONAKI UTA	Turkey in the Straw	Starting Notice Chime 2
	Channel7	Starting Notice Chime 3	Ending Notice Chime 1	Ending Notice Chime 2	Jalopy Horn	Train Ride	Furusato	Funiculi, Funicula	Chime
	Channel8	Stutter	Stutter	Stutter	Stutter	Stutter	BEAUTIFUL DREAMER	JOLLY HOLIDAY	Call Sign

Type G	Channel1	Can-can	KAERUNO GASSHOU	Nedelka	The Parade of the Tin Soldiers	Galactic Hovercraft	Fur Elise	Mary had a little Lamb	Ave Maria
	Channel2	Radetzky March	El Condor Pasa (If I Could)	Moonlight Serenade	J'ai perdu le do de ma clarinette	Game Intermission	Bach Minuet in Gmjr	Camptown Races	Grandfather's Clock
	Channel3	Funiculi, Funicula	Hungarian Dance No.5	WAREWA UMINO KO	Funiculi, Funicula	Spring Melody	Annie Laurie	Amaryllis	Radetzky March
	Channel4	Csikos Post	William Tell Overture	Spring Melody	Nedelka	Jalopy Horn	London Bridge is falling down	Mozart Symphony No.40	Polka Trablanka
	Channel5	Polka Trablanka	Pomp and Circumstance	Jalopy Horn	RR-crossing	ET Doorbell	If You're Happy and You Know It	Flea Waltz	O Vreneli
	Channel6	O Vreneli	Greensleeves	ET Doorbell	Starting Notice Chime 2	RR-crossing	Csikos Post	Turkey in the Straw	El Condor Pasa (If I Could)
	Channel7	Galactic Hovercraft	Galactic Hovercraft	Starting Notice Chime 1	Ending Notice Chime 2	Starting Notice Chime 1	KAERUNO GASSHOU	The Battle Hymn of the Republic	Hungarian Dance No.5
	Channel8	Game Intermission	Game Intermission	Ending Notice Chime 1	Chime	Ending Notice Chime 2	Greensleeves	Can-can	William Tell Overture

Although copyright licensing has been acquired for the F type in Japan for our company, since the copyright licensing for countries outside Japan has not been acquired, if used in countries other than Japan, there is a necessity to acquire copyright licensing for the customer.