

Drawing No.	Rev.	Page
CWF3S-24-W18	A	1/2

SPECIFICATIONS

[General Specifications]

Product Name	LED Work Light	
Model	CWF3S-24-CD	
Rated Voltage	24V DC	
Operating Voltage Range	Rated Voltage $\pm 10\%$	
Rated Power Consumption	Max.	5 W
Luminous Color	Daylight	
Color Temperature	Typ.	5700 K
Total Luminous Flux	Typ.	500 lm
Illuminance (1m , Center)	Typ.	165 lx
Operating Ambient Temperature	-25 °C to +60 °C	
Operating Ambient Humidity	Less than 90% (No condensation)	
Mounting Location	Indoor	
Mounting Direction	All Directions	
Protection Rating	IP20	
Environmental Condition	All Directions	
Insulation Resistance	More than 5M Ω at 500VDC between live part and non-current carrying metallic part	
Withstand Voltage	500VAC applied for 1min between live part and non-current carrying metallic part without breaking insulation	
Mass (Tolerance $\pm 10\%$)	420 g	
Outer Dimensions	Refer to the Outer Dimension Drawing	
Conformity Standards	UL 2108 , CSA C22.2 No. 250.0 EMC Directive (EN 61000-6-4, EN 61000-6-2) FCC Part 15 Subpart B Class A	
Remarks	Specifications and dimensions may change without prior notice for improvements, etc. Due to the characteristics of the LED, color temperature, brightness and hue will differ for every LED and every product.	

[Model Number Configuration]

Model			Rated Voltage	Luminous Color
CWF	3	S	- 24	- CD

Length

3 | 300mm

Rated Voltage

24 | 24V DC

Luminous Color

CD | Daylight

生産終了

Production end

Drawing No.	Rev.	Page
CWF3S-24-W18	A	2/2

[Outer Dimension Drawing]

[Unit : mm]

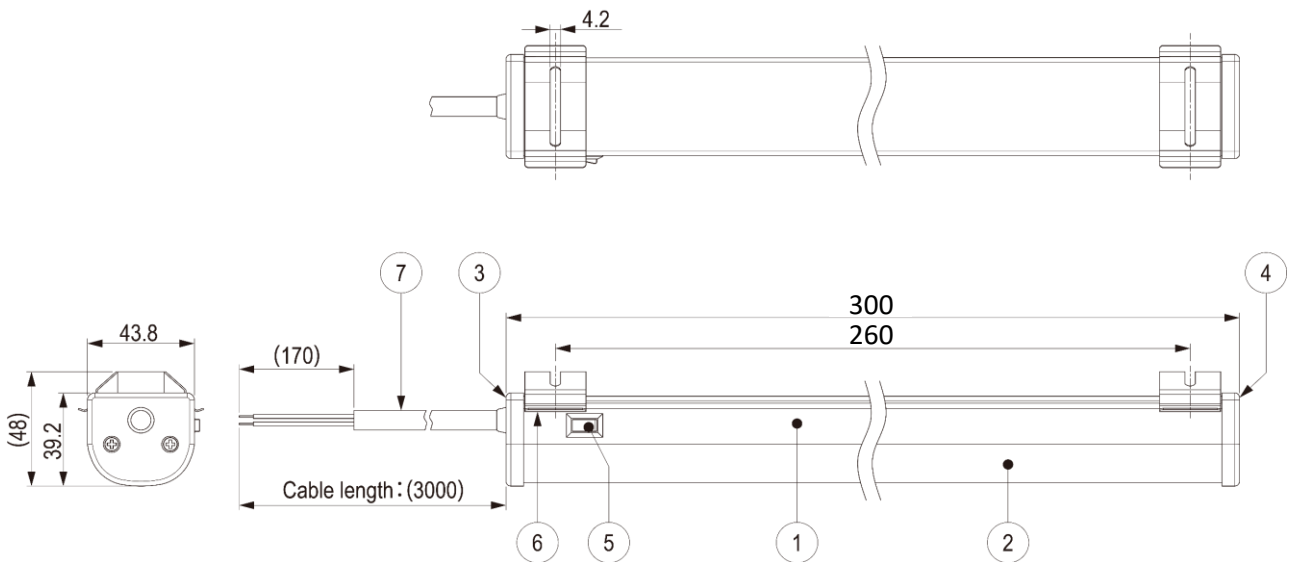

Number	Name	Material etc
1	Frame	AL
2	Cover	PC
3	Cap A	PC
4	Cap B	PC
5	Switch	-
6	Bracket	Spring Steel
7	Cable	UL SJT

[Wiring Diagram]

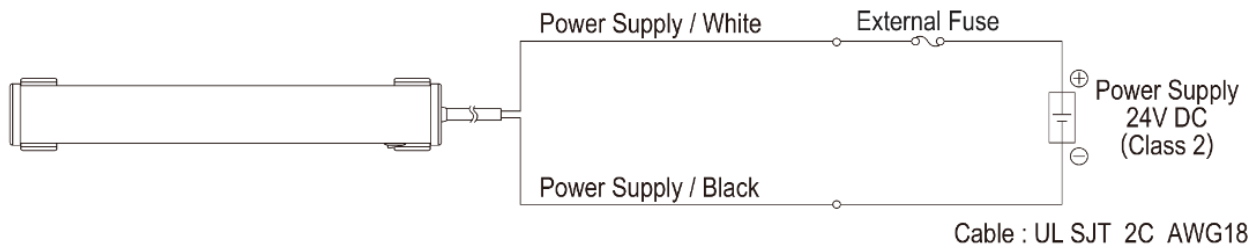

生産終了
Production end